



price &
specification
guide 2016



Contents Furniture

Desking:



move! 6



Arc 18



Vega 28



Alto 38



Soho² 48



Soho³ 54



K2C 64



Contrax2 P 68



Contrax2 C 70



Cirrus 72



Screens 76



Meeting Extensions 84

Conference & Meeting:



Tip Top Folding / Mobile 86



Meeting Tables 88



Conference Tables 94



Breakout Tables 97



Accessories 98

Storage:



Storage 102



Lockers 110



StorageWall 112

Reception:



Reception Counters 118

Specification Information:



Desking Finishes 166



Screen Finishes 167



Storage Options 168



Reception Specifications 169



StorageWall Specifications 170

General Information:

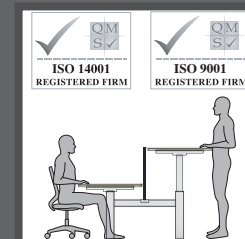

Standards & Specifications 173



Environment Policy & CSR 176

Contents Seating

Task Seating:



Nero 124



Verdi 126



Zel 127



Touch 128



Spirit 129

Executive Seating:



Aquila 132



Libra 133



Memphis 134



Otto 135



Encore 136

Meeting Seating:



Otto 137



Sienna 138



Visita 139



Aquila 140



Libra 141



Memphis 142



Encore 143



Felix 144



Class 145

Breakout:



Edith 146



Eva 147



Harriet 148



Grace 149



Elba 150



Aria 151



Norma 152



Emily 153

Soft Seating:



Papa 154



Auriga 155



Avenue 156



Ad-Hoc 158



Snug 159



Zone 160

	move! Electric	move! Crank	move! Set & Forget
Category	Sit - Stand	Sit - Sit	Sit - Stand
Minimum to maximum height (mm)	680 - 1180	680 - 920	680 - 1180
User adjustable control	Yes	Yes	No
Single desk option	Yes	Yes	Yes
Back to back bench option	Yes	Yes	Yes
Drive system	Twin Motor	Crank	-
Load capacity (kg)	80	45	80
Frame fixed screen mounting facility (back to back benches only)	Yes	Yes	Yes
Central frame fixed cable tray option	Yes	Yes	Yes
Individual top fixed cable tray option	Yes	Yes	Yes
Speed	35mm/sec	3mm/Turn	-
Noise emission (db)	39	-	-
Standby power consumption (w)	0.1	-	-

UK DESIGNED | 5 YEAR WARRANTY | 39dB | HIGH SPEED 35mm/sec | 80kg CAPACITY | 0.1W STANDBY POWER | TWIN MOTORS | BACK TO BACK | SIT STAND



move! Electric back to back benches shown in white with candy bar end cladding in hacienda black.

Back to Back Bench

Includes sliding tops



Description	Code	W	D	H	Price £	
Top Options: A = Beech, Maple, Oak, White B = Cherry, Hacienda Black, Walnut, Zebrano					A	B
Frame Options Suffix Code: S = Silver W = White						
Tops with square corners	UEN-2PB-128	1200	1680	680-1180	2051	2083
	UEN-2PB-148	1400	1680	680-1180	2056	2088
	UEN-2PB-168	1600	1680	680-1180	2099	2134
	UEN-2PB-188	1800	1680	680-1180	2144	2184
Tops with cable ports and square corners	UEP-2PB-128	1200	1680	680-1180	2063	2095
	UEP-2PB-148	1400	1680	680-1180	2068	2100
	UEP-2PB-168	1600	1680	680-1180	2112	2147
	UEP-2PB-188	1800	1680	680-1180	2158	2196
Tops with scallop and rounded corners	UES-2PB-128	1200	1680	680-1180	2125	2157
	UES-2PB-148	1400	1680	680-1180	2130	2162
	UES-2PB-168	1600	1680	680-1180	2173	2208
	UES-2PB-188	1800	1680	680-1180	2220	2258

Single Desk



Description	Code	W	D	H	Price £	
Top Options: A = Beech, Maple, Oak, White B = Cherry, Hacienda Black, Walnut, Zebrano					A	B
Frame Options Suffix Code: S = Silver W = White						
Tops with square corners	UEN-DSK-128	1200	800	680-1180	1113	1129
	UEN-DSK-148	1400	800	680-1180	1115	1131
	UEN-DSK-168	1600	800	680-1180	1136	1154
	UEN-DSK-188	1800	800	680-1180	1158	1177
Tops with cable ports and square corners	UEP-DSK-128	1200	800	680-1180	1120	1135
	UEP-DSK-148	1400	800	680-1180	1122	1137
	UEP-DSK-168	1600	800	680-1180	1142	1160
	UEP-DSK-188	1800	800	680-1180	1164	1183
Tops with scallop and rounded corners	UES-DSK-128	1200	800	680-1180	1151	1166
	UES-DSK-148	1400	800	680-1180	1153	1168
	UES-DSK-168	1600	800	680-1180	1173	1191
	UES-DSK-188	1800	800	680-1180	1195	1214
Premium controller with 4 height presets and digital read-out	UEX-PRE-CON	150		42	124	-



UK DESIGNED | 5 YEAR WARRANTY | 39dB | HIGH SPEED 35mm/sec | 80kg CAPACITY | 0.1W STANDBY POWER | TWIN MOTORS | BACK TO BACK | SINGLE SIDED | SIT STAND

move! Crank 2 person back to back benches shown in white with optional cable trays. Slimline end cladding shown in walnut.



Back to Back Bench



Description	Code	W	D	H	Price £	
					A	B
Top Options: A = Beech, Maple, Oak, White B = Cherry, Hacienda Black, Walnut, Zebrano					A	B
Frame Options Suffix Code: W = White (Not available in silver)						
Tops with square corners	UCN-2PB-148	1400	1680	680-920	1613	1644
	UCN-2PB-168	1600	1680	680-920	1655	1691
	UCN-2PB-188	1800	1680	680-920	1702	1740
Tops with cable ports and square corners	UCP-2PB-148	1400	1680	680-920	1625	1657
	UCP-2PB-168	1600	1680	680-920	1669	1704
	UCP-2PB-188	1800	1680	680-920	1714	1752
Tops with scallop and rounded corners	UCS-2PB-148	1400	1680	680-920	1687	1719
	UCS-2PB-168	1600	1680	680-920	1730	1765
	UCS-2PB-188	1800	1680	680-920	1776	1814

Single Desk



Description	Code	W	D	H	Price £	
					A	B
Top Options: A = Beech, Maple, Oak, White B = Cherry, Hacienda Black, Walnut, Zebrano					A	B
Frame Options Suffix Code: W = White (Not available in silver)						
Tops with square corners	UCN-DSK-148	1400	800	680-920	889	904
	UCN-DSK-168	1600	800	680-920	908	926
	UCN-DSK-188	1800	800	680-920	931	950
Tops with cable ports and square corners	UCP-DSK-148	1400	800	680-920	895	911
	UCP-DSK-168	1600	800	680-920	916	933
	UCP-DSK-188	1800	800	680-920	937	956
Tops with scallop and rounded corners	UCS-DSK-148	1400	800	680-920	926	941
	UCS-DSK-168	1600	800	680-920	947	964
	UCS-DSK-188	1800	800	680-920	968	987

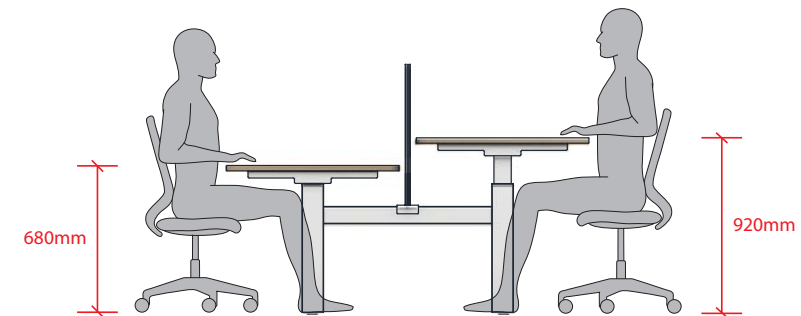

- UK DESIGNED**
- 5 YEAR WARRANTY**
- HIGH SPEED 3mm/rev**
- 45kg CAPACITY**
- BACK TO BACK**
- SINGLE SIDED**
- SIT SIT**

move! Set and Forget single desk shown in white and walnut with worktop mounted cable tray option. Fly by modesty screen shown with slimline end cladding and return caddy.

Back to Back Bench

Includes sliding tops



Description	Code	W	D	H	Price £	
					A	B
Top Options: A = Beech, Maple, Oak, White B = Cherry, Hacienda Black, Walnut, Zebrano						
Frame Options Suffix Code: S = Silver W = White						
Tops with square corners	UMN-2PB-128	1200	1680	680-1180	1057	1088
	UMN-2PB-148	1400	1680	680-1180	1062	1093
	UMN-2PB-168	1600	1680	680-1180	1104	1139
	UMN-2PB-188	1800	1680	680-1180	1151	1189
Tops with cable ports and square corners	UMP-2PB-128	1200	1680	680-1180	1069	1100
	UMP-2PB-148	1400	1680	680-1180	1074	1105
	UMP-2PB-168	1600	1680	680-1180	1118	1153
	UMP-2PB-188	1800	1680	680-1180	1163	1201
Tops with scallop and rounded corners	UMS-2PB-128	1200	1680	680-1180	1131	1162
	UMS-2PB-148	1400	1680	680-1180	1136	1167
	UMS-2PB-168	1600	1680	680-1180	1179	1214
	UMS-2PB-188	1800	1680	680-1180	1225	1263

Single Desk



Description	Code	W	D	H	Price £	
					A	B
Top Options: A = Beech, Maple, Oak, White B = Cherry, Hacienda Black, Walnut, Zebrano						
Frame Options Suffix Code: S = Silver W = White						
Tops with square corners	UMN-DSK-128	1200	800	680-1180	615	631
	UMN-DSK-148	1400	800	680-1180	617	633
	UMN-DSK-168	1600	800	680-1180	638	655
	UMN-DSK-188	1800	800	680-1180	660	679
Tops with cable ports and square corners	UMP-DSK-128	1200	800	680-1180	622	638
	UMP-DSK-148	1400	800	680-1180	624	640
	UMP-DSK-168	1600	800	680-1180	644	661
	UMP-DSK-188	1800	800	680-1180	666	685
Tops with scallop and rounded corners	UMS-DSK-128	1200	800	680-1180	653	669
	UMS-DSK-148	1400	800	680-1180	655	671
	UMS-DSK-168	1600	800	680-1180	675	692
	UMS-DSK-188	1800	800	680-1180	697	716

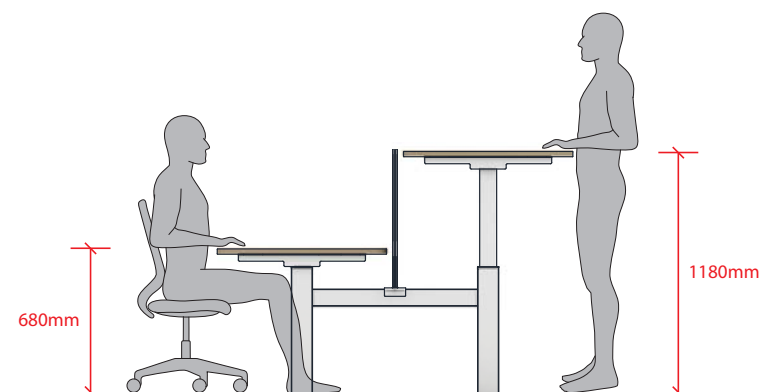

UK DESIGNED | 5 YEAR WARRANTY | 80kg CAPACITY | BACK TO BACK | SINGLE SIDED | SIT STAND



move! Electric 1600mm single desk shown with rounded corners in cherry and matching modesty panel, 1400mm desk up screen. High mobile 3 drawer pedestal.

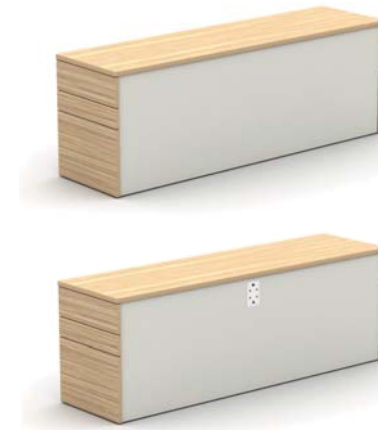

Description	Code	W	D	H	Price £	
					A	B
Options: A = Beech, Maple, Oak, White B = Cherry, Hacienda Black, Walnut, Zebrano						
Carcass Options Suffix Code: S = Silver W = White						
Back to back storage pedestal for end positions	UXX-PED-END	430	1680	585	726	799
Back to back storage pedestal with through cable access for intermediate positions	UXX-PED-INT	430	1680	585	752	827



Description	Code	W	D	H	Price £	
					A	B
Frame Options Suffix Code: S = Silver W = White						
Back to back bench frame fixed sit on cable tray including cover	UXM-CTS-123	1200	290	105	170	-
	UXM-CTS-143	1400	290	105	176	-
	UXM-CTS-163	1600	290	105	185	-
	UXM-CTS-183	1800	290	105	206	-
End cap for frame fixed sit on cable tray	UXM-CTE-CAP	290		105	27	-
Back to back bench cable tray fixing brackets (Only required if no screens are specified)	UXM-CTF-BRK				19	-
Telescopic single cable tray with hangers for under worktop mounting	UXM-CTT-LGE	1400-1800	150		129	-
	UXM-CTT-SML	900-1400	150		111	-
Modesty panel with square corners	UXN-MOD-123	1200	300	18	108	118
	UXN-MOD-143	1400	300	18	113	123
	UXN-MOD-163	1600	300	18	118	129
	UXN-MOD-183	1800	300	18	124	135
Modesty panel with rounded corners and scallop	UXS-MOD-123	1200	300	18	134	144
	UXS-MOD-143	1400	300	18	140	150
	UXS-MOD-163	1600	300	18	146	158
	UXS-MOD-183	1800	300	18	152	165
Cable sock with zip for vertical floor to sit on cable tray cable management	CAB-SOC-LOW	100		570	130	-
Cable sock with zip for vertical floor to sit on cable tray top cable Management	CAB-SOC-HIG	40		600	73	-
Extendable spiral cable spine Suitable for height adjustable desking	CAB-SPI-FLX-SIL			680-1180	71	
Universal CPU holder for under mounting CPU to desk top frame	UXX-CPU-HOL	250	500	420	140	-

move! Electric back to back benches shown in white with candy bar end cladding in walnut. White acrylic screens.



Single Side Slimline



Description	Code	W	D	H	Price £	
Options: A = Beech, Maple, Oak, White B = Cherry, Hacienda Black, Walnut, Zebrano					A	B
Square corners	UXC-SSS-800	800	25	495	103	110
Rounded corners	UXC-SSR-800	800	25	495	134	141

Back to Back Slimline

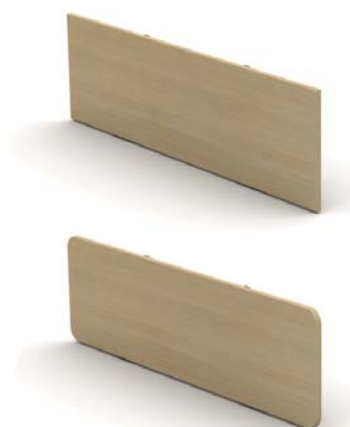

Description	Code	W	D	H	Price £	
Options: A = Beech, Maple, Oak, White B = Cherry, Hacienda Black, Walnut, Zebrano					A	B
Square corners	UXC-SBS-168	1680	25	495	163	175
Rounded corners	UXC-SBR-168	1680	25	495	194	206

move! Electric back to back benches shown in sand zebrano with back to back storage pedestals.



Back to Back Candy Bar



Description	Code	W	D	H	Price £	
Options: A = Beech, Maple, Oak, White B = Cherry, Hacienda Black, Walnut, Zebrano					A	B
Frame Options Suffix Code: S = Silver W = White						
Rounded corners Not compatible with Set and Forget frames	UXC-CBR-168	1680	86	555	819	843



move! Electric back to back benches shown in sand zebrano and white with optional frame fixed cable trays and end cap.



move! Electric single desk shown in cherry and white with high mobile bow fronted steel pedestal.

Description	Code	W	D	H	Price £				
					A	B	C	D	E
For finish options please see page 167									
Frame Options Suffix Code: S = Silver W = White									
Screens for freestanding back to back desks	US4-2PB-127	1200	25	1200	336	364	565	424	567
	US4-2PB-147	1400	25	1200	380	413	586	481	644
	US4-2PB-167	1600	25	1200	390	424	614	494	688
	US4-2PB-187	1800	25	1200	426	462	635	539	760
Starter screens for back to back desks	US4-STR-127	1200	25	1200	345	373	573	432	576
	US4-STR-147	1400	25	1200	389	422	595	490	653
	US4-STR-167	1600	25	1200	399	433	623	502	697
	US4-STR-187	1800	25	1200	435	471	644	548	769
Add on screens for back to back desks	US4-ADD-127	1200	25	1200	335	363	564	423	566
	US4-ADD-147	1400	25	1200	379	412	585	480	643
	US4-ADD-167	1600	25	1200	389	423	613	493	687
	US4-ADD-187	1800	25	1200	425	461	634	538	759
End screens for back to back desks	US4-END-127	1200	25	1200	326	354	555	414	558
	US4-END-147	1400	25	1200	370	403	576	471	634
	US4-END-167	1600	25	1200	380	414	604	484	678
	US4-END-187	1800	25	1200	416	452	625	529	750

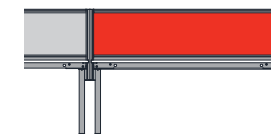
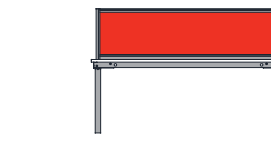

All screens include heavy duty frame mounted brackets.

If starter / add on / end screens are used the the screen brackets set the spacing of the desks at 25mm between worktops for user safety.

Description	Code	W	D	H	Price £				
					A	B	C	D	E
For finish options please see page 167									
Frame Options Suffix Code: S = Silver W = White									
Fly by modesty screen	US4-FBT-126	1200	25	600	338	363	544	417	546
	US4-FBT-146	1400	25	600	377	407	563	469	615
	US4-FBT-166	1600	25	600	387	417	588	480	655
	US4-FBT-186	1800	25	600	419	452	607	521	719
Fly by slatwall modesty screen	US4-FBX-126	1200	25	600	417	443	623	496	626
	US4-FBX-146	1400	25	600	470	500	655	562	708
	US4-FBX-166	1600	25	600	493	523	694	586	761
	US4-FBX-186	1800	25	600	539	571	727	640	839
Desk up screen (330 Above desktop)	US4-DUP-124	1200	25	400	322	345	435	395	528
	US4-DUP-144	1400	25	400	336	361	454	414	615
	US4-DUP-164	1600	25	400	349	375	461	430	655
	US4-DUP-184	1800	25	400	363	391	499	449	719



All screens include die cast heavy duty top mounted brackets.

Arc

2 Person Back to Back Configuration



Description	Code	W	D	H	Price £	
					A	B
Top Options: A = Beech, Maple, Oak, White B = Cherry, Hacienda Black, Walnut, Zebrano						
Frame Options Suffix Code: S = Silver W = White						
Includes telescopic cable tray	R2D126	1200	1250	720	841	865
	R2D146	1400	1250	720	867	893
	R2D166	1600	1250	720	974	1004
	R2D186	1800	1250	720	980	1012
	R2D206	2000	1250	720	1008	1038
	R2D128	1200	1650	720	901	931
	R2D148	1400	1650	720	923	953
	R2D168	1600	1650	720	1072	1108
	R2D188	1800	1650	720	1076	1112
	R2D208	2000	1650	720	1104	1142

Arc

6 Person Back to Back Configuration



Description	Code	W	D	H	Price £	
					A	B
Top Options: A = Beech, Maple, Oak, White B = Cherry, Hacienda Black, Walnut, Zebrano						
Frame Options Suffix Code: S = Silver W = White						
Includes telescopic cable tray	R6D126	1200	1250	720	2217	2289
	R6D146	1400	1250	720	2295	2373
	R6D166	1600	1250	720	2616	2706
	R6D186	1800	1250	720	2634	2730
	R6D206	2000	1250	720	2718	2808
	R6D128	1200	1650	720	2363	2453
	R6D148	1400	1650	720	2429	2519
	R6D168	1600	1650	720	2876	2984
	R6D188	1800	1650	720	2888	2996
	R6D208	2000	1650	720	2972	3086

4 Person Back to Back Configuration



Description	Code	W	D	H	Price £	
					A	B
Top Options: A = Beech, Maple, Oak, White B = Cherry, Hacienda Black, Walnut, Zebrano						
Frame Options Suffix Code: S = Silver W = White						
Includes telescopic cable tray	R4D126	1200	1250	720	1529	1577
	R4D146	1400	1250	720	1581	1633
	R4D166	1600	1250	720	1795	1855
	R4D186	1800	1250	720	1807	1871
	R4D206	2000	1250	720	1863	1923
	R4D128	1200	1650	720	1632	1692
	R4D148	1400	1650	720	1676	1736
	R4D168	1600	1650	720	1974	2046
	R4D188	1800	1650	720	1982	2054
	R4D208	2000	1650	720	2038	2114

8 Person Back to Back Configuration



Description	Code	W	D	H	Price £	
					A	B
Top Options: A = Beech, Maple, Oak, White B = Cherry, Hacienda Black, Walnut, Zebrano						
Frame Options Suffix Code: S = Silver W = White						
Includes telescopic cable tray	R8D126	1200	1250	720	2905	3001
	R8D146	1400	1250	720	3009	3113
	R8D166	1600	1250	720	3437	3557
	R8D186	1800	1250	720	3461	3589
	R8D206	2000	1250	720	3573	3693
	R8D128	1200	1650	720	3094	3214
	R8D148	1400	1650	720	3182	3302
	R8D168	1600	1650	720	3778	3922
	R8D188	1800	1650	720	3794	3938
	R8D208	2000	1650	720	3906	4058

Arc

Back to Back Starter Module

Description	Code	W	D	H	Price £	
Top Options: A = Beech, Maple, Oak, White B = Cherry, Hacienda Black, Walnut, Zebrano					A	B
Frame Options Suffix Code: S = Silver W = White						

Includes telescopic cable tray

RSUS1012	1000	1250	720	827	851
RSUS1212	1200	1250	720	841	865
RSUS1412	1400	1250	720	867	893
RSUS1612	1600	1250	720	974	1004
RSUS1812	1800	1250	720	980	1012
RSUS2012	2000	1250	720	1008	1038

RSUS1016	1000	1650	720	897	927
RSUS1216	1200	1650	720	901	931
RSUS1416	1400	1650	720	923	953
RSUS1616	1600	1650	720	1072	1108
RSUS1816	1800	1650	720	1076	1112
RSUS2016	2000	1650	720	1104	1142

Back to Back Add on Module

Includes telescopic cable tray

RAOS1012	1000	1250	720	674	698
RAOS1212	1200	1250	720	688	712
RAOS1412	1400	1250	720	714	740
RAOS1612	1600	1250	720	821	851
RAOS1812	1800	1250	720	827	859
RAOS2012	2000	1250	720	855	885

RAOS1016	1000	1650	720	727	757
RAOS1216	1200	1650	720	731	761
RAOS1416	1400	1650	720	753	783
RAOS1616	1600	1650	720	902	938
RAOS1816	1800	1650	720	906	942
RAOS2016	2000	1650	720	934	972

Arc back to back six person configuration shown with sliding top kit, sand zebrano tops and S3 tool rail.



Arc

Single Starter Module

Description	Code	W	D	H	Price £	
Top Options: A = Beech, Maple, Oak, White B = Cherry, Hacienda Black, Walnut, Zebrano					A	B
Frame Options Suffix Code: S = Silver W = White						

Includes telescopic cable tray

RSSS1006	1000	600	720	496	508
RSSS1206	1200	600	720	503	515
RSSS1406	1400	600	720	516	529
RSSS1606	1600	600	720	576	591
RSSS1806	1800	600	720	579	595
RSSS2006	2000	600	720	593	608

RSSS1008	1000	800	720	523	538
RSSS1208	1200	800	720	525	540
RSSS1408	1400	800	720	536	551
RSSS1608	1600	800	720	617	635
RSSS1808	1800	800	720	619	637
RSSS2008	2000	800	720	633	652

Single Add on Module







Includes telescopic cable tray



RSAS1006	1000	600	720	455	467
RSAS1206	1200	600	720	462	474
RSAS1406	1400	600	720	475	488
RSAS1606	1600	600	720	535	550
RSAS1806	1800	600	720	538	554
RSAS2006	2000	600	720	552	567

RSAS1008	1000	800	720	476	491
RSAS1208	1200	800	720	478	493
RSAS1408	1400	800	720	489	504
RSAS1608	1600	800	720	570	588
RSAS1808	1800	800	720	572	590
RSAS2008	2000	800	720	586	605

Arc back to back six person configuration shown with hacienda black tops and white leg frames. Optional dump kits fitted.



Description	Code	W	D	H	Price £		
					A	B	
Top Options: A = Beech, Maple, Oak, White B = Cherry, Hacienda Black, Walnut, Zebrano							
Frame Options Suffix Code: S = Silver W = White							
	Rectangular desk	RD1Ø	1000	800	720	436	451
		RD12	1200	800	720	438	453
		RD14	1400	800	720	449	464
		RD16	1600	800	720	512	530
		RD18	1800	800	720	514	532
		RD20	2000	800	720	528	547
	Flare desk	RW12L/R	1200	800-900	720	479	498
	RH illustrated	RW14L/R	1400	800-900	720	496	515
		RW16L/R	1600	800-900	720	535	554
		RW18L/R	1800	800-900	720	558	581
	Core workstation	RC16L/R	1600	1200	720	668	690
	Ends are 800d x 600d RH illustrated	RC18L/R	1800	1200	720	701	726
	Core workstation	RCB16L/R	1600	1200	720	577	599
	With pedestal bracket Ends are 800d x 600d RH illustrated	RCB18L/R	1800	1200	720	610	635
	Radial workstation	RW161686L/R	1600	1600	720	715	742
	Ends are 800d x 600d RH illustrated						
	Radial workstation	RWSP161686L/R	1600	1600	720	610	637
	For supporting pedestal (Not included) Ends are 800d x 600d RH illustrated						
	Return desk	RR1ØF	1000	600	720	409	421
	Freestanding	RR12F	1200	600	720	416	428
		RR14F	1400	600	720	429	442
		RR16F	1600	600	720	471	486

Description	Code	W	D	H	Price £		
					A	B	
Top Options: A = Beech, Maple, Oak, White B = Cherry, Hacienda Black, Walnut, Zebrano							
Frame Options Suffix Code: S = Silver W = White							
	Return desk	RR1ØC	1000	600	720	377	389
	Connecting	RR12C	1200	600	720	384	396
		RR14C	1400	600	720	397	410
		RR16C	1600	600	720	439	454
	120° Delta workstation						
	1115 x 1115 x 600 x 600	R12Ø6	1115	1115	720	532	557
	1115 x 1115 x 800 x 800	R12Ø8	1115	1115	720	559	585
	Delta cluster						
	1115 x 1115 x 600 x 600	R3WSD12Ø6	1115	1115	720	1623	1698
	1115 x 1115 x 800 x 800	R3WSD12Ø8	1115	1115	720	1728	1806



Arc rectangular desk shown with sand zebrano top and white frame. Aquila chair in white leather.



Arc two person back to back desk shown in hacienda black with S3 tool rail. Return caddy also shown.



Arc two person back to back desk shown in sand zebrano with S3 tool rail.

Description	Code	W	D	H	Price £		
					A	B	C
Top Options: A = Beech, Maple, Oak, White B = Cherry, Hacienda Black, Walnut, Zebrano. C = Glass in Black, White or Frosted							
Desk tops	RDT10	1000	800	25	140	155	POA
	RDT12	1200	800	25	142	157	POA
	RDT14	1400	800	25	145	160	POA
	RDT16	1600	800	25	174	192	POA
	RDT18	1800	800	25	176	194	POA
	RDT20	2000	800	25	190	209	POA
Flare tops	RFT12L/R	1200	800-900	25	183	202	-
	RFT14L/R	1400	800-900	25	192	211	-
	RFT16L/R	1600	800-900	25	197	216	-
	RFT18L/R	1800	800-900	25	220	243	-
Core tops	RCT16L/R	1600	1200	25	225	247	-
	RCT18L/R	1800	1200	25	258	283	-
Radial tops	RLT16L/R	1600	1600	25	272	299	-
Delta tops	RCC1206	1115	600	25	249	274	-
	RCC1208	1115	800	25	264	290	-
Return tops	RRT10	1000	600	25	125	137	-
	RRT12	1200	600	25	132	144	-
	RRT14	1400	600	25	137	150	-
	RRT16	1600	600	25	145	160	-
	RRT18	1800	600	25	148	164	-
	RRT20	2000	600	25	162	177	-
Modesty panels	RM10	1000	300	25	116	128	-
	RM12	1200	300	25	122	133	-
	RM14	1400	300	25	128	138	-
	RM16	1600	300	25	133	143	-
	RM18	1800	300	25	138	148	-
	RM20	2000	300	25	143	153	-

Description	Code	W	D	H	Price £
Frame Options Suffix Code: S = Silver W = White					
Single post leg	RSL			720	73
600 Leg	R6L			720	105
800 Leg	R8L			720	111
1250 End/Shared leg	R12L			720	164
1250 Intermediate leg	R12IL			720	175
1650 End/Shared leg	R16L			720	184
1650 Intermediate leg	R16IL			720	198
Cable dump kit	RCDK1650 RCDK1250				122 122

Description	Code	W	D	H	Price £
Frame Options Suffix Code: S = Silver W = White					
Telescopic beam	Long RLTB Medium RMTB Short RSTB	1410-2000 1210-1400 1000-1200			58 41 37
Telescopic double cable tray	Large RLTDCT Small RSTDCT	1410-2000 900-1400	250 250		104 81
Telescopic single cable tray	Large RLTSCT Small RSTSCT	1410-2000 900-1400	150 150		85 67
Deep cable tray hanger set	RLCTH			161/170	20
Positions tray 161mm from the underside of desk tops on back to back desks, 170mm on single side desks					
Shallow cable tray hanger set	RSCTH			97/106	20
Positions tray 97mm from the underside of desk tops on back to back desks, 106mm on single side desks					
Fit anywhere tray hanger bracket	RFACTH			129	20
For use when cable trays need to be fitted to the desk top.					
Double cable tray end cap	RDCTEBP				15
Single cable tray end cap	RSCTEBP				15
Single side extension beam brackets	RSSEBB				64
For use when beams need to be attached to both sides of 800 and 600 end legs.					
800 Connecting return inner bracket	RCRIB8				78
600 Connecting return inner bracket	RCRIB6				73
Sliding top kit					
For 800d tops	RSTK				49
For 600d tops	RSTK6				49
Height adjustable kit					
For 800d tops	RHAK8				156
For 600d tops	RHAK6				156
Allows adjustment from 720h to 800h					

Vega

2 Person Back to Back Configuration



Description	Code	W	D	H	Price £	
Top Options: A = Beech, Maple, Oak, White B = Cherry, Hacienda Black, Walnut, Zebrano					A	B
Frame Options Suffix Code: S = Silver W = White						
Includes telescopic cable tray	V2D126	1200	1250	720	841	865
	V2D146	1400	1250	720	867	893
	V2D166	1600	1250	720	974	1004
	V2D186	1800	1250	720	980	1012
	V2D206	2000	1250	720	1008	1038
	V2D128	1200	1650	720	901	931
	V2D148	1400	1650	720	923	953
	V2D168	1600	1650	720	1072	1108
	V2D188	1800	1650	720	1076	1112
	V2D208	2000	1650	720	1104	1142

Vega

6 Person Back to Back Configuration



Description	Code	W	D	H	Price £	
Top Options: A = Beech, Maple, Oak, White B = Cherry, Hacienda Black, Walnut, Zebrano					A	B
Frame Options Suffix Code: S = Silver W = White						
Includes telescopic cable tray	V6D126	1200	1250	720	2217	2289
	V6D146	1400	1250	720	2295	2373
	V6D166	1600	1250	720	2616	2706
	V6D186	1800	1250	720	2634	2730
	V6D206	2000	1250	720	2718	2808
	V6D128	1200	1650	720	2363	2453
	V6D148	1400	1650	720	2429	2519
	V6D168	1600	1650	720	2876	2984
	V6D188	1800	1650	720	2888	2996
	V6D208	2000	1650	720	2972	3086

4 Person Back to Back Configuration



Description	Code	W	D	H	Price £	
Top Options: A = Beech, Maple, Oak, White B = Cherry, Hacienda Black, Walnut, Zebrano					A	B
Frame Options Suffix Code: S = Silver W = White						
Includes telescopic cable tray	V4D126	1200	1250	720	1529	1577
	V4D146	1400	1250	720	1581	1633
	V4D166	1600	1250	720	1795	1855
	V4D186	1800	1250	720	1807	1871
	V4D206	2000	1250	720	1863	1923
	V4D128	1200	1650	720	1632	1692
	V4D148	1400	1650	720	1676	1736
	V4D168	1600	1650	720	1974	2046
	V4D188	1800	1650	720	1982	2054
	V4D208	2000	1650	720	2038	2114

8 Person Back to Back Configuration



Description	Code	W	D	H	Price £	
Top Options: A = Beech, Maple, Oak, White B = Cherry, Hacienda Black, Walnut, Zebrano					A	B
Frame Options Suffix Code: S = Silver W = White						
Includes telescopic cable tray	V8D126	1200	1250	720	2905	3001
	V8D146	1400	1250	720	3009	3113
	V8D166	1600	1250	720	3437	3557
	V8D186	1800	1250	720	3461	3589
	V8D206	2000	1250	720	3573	3693
	V8D128	1200	1650	720	3094	3214
	V8D148	1400	1650	720	3182	3302
	V8D168	1600	1650	720	3778	3922
	V8D188	1800	1650	720	3794	3938
	V8D208	2000	1650	720	3906	4058

Vega

Back to Back Starter Module



Description	Code	W	D	H	Price £	
					A	B
Top Options: A = Beech, Maple, Oak, White B = Cherry, Hacienda Black, Walnut, Zebrano						
Frame Options Suffix Code: S = Silver W = White						
Includes telescopic cable tray	VSUS1012	1000	1250	720	827	851
	VSUS1212	1200	1250	720	841	865
	VSUS1412	1400	1250	720	867	893
	VSUS1612	1600	1250	720	974	1004
	VSUS1812	1800	1250	720	980	1012
	VSUS2012	2000	1250	720	1008	1038
	VSUS1016	1000	1650	720	897	927
	VSUS1216	1200	1650	720	901	931
	VSUS1416	1400	1650	720	923	953
	VSUS1616	1600	1650	720	1072	1108
	VSUS1816	1800	1650	720	1076	1112
	VSUS2016	2000	1650	720	1104	1142
	VAOS1012	1000	1250	720	674	698
	VAOS1212	1200	1250	720	688	712
	VAOS1412	1400	1250	720	714	740
	VAOS1612	1600	1250	720	821	851
	VAOS1812	1800	1250	720	827	859
	VAOS2012	2000	1250	720	855	885
	VAOS1016	1000	1650	720	727	757
	VAOS1216	1200	1650	720	731	761
	VAOS1416	1400	1650	720	753	783
	VAOS1616	1600	1650	720	902	938
	VAOS1816	1800	1650	720	906	942
	VAOS2016	2000	1650	720	934	972

Back to Back Add on Module



Vega

Single Starter Module



Description	Code	W	D	H	Price £	
					A	B
Top Options: A = Beech, Maple, Oak, White B = Cherry, Hacienda Black, Walnut, Zebrano						
Frame Options Suffix Code: S = Silver W = White						
Includes telescopic cable tray	VSSS1006	1000	600	720	496	508
	VSSS1206	1200	600	720	503	515
	VSSS1406	1400	600	720	516	529
	VSSS1606	1600	600	720	576	591
	VSSS1806	1800	600	720	579	595
	VSSS2006	2000	600	720	593	608
	VSSS1008	1000	800	720	523	538
	VSSS1208	1200	800	720	525	540
	VSSS1408	1400	800	720	536	551
	VSSS1608	1600	800	720	617	635
	VSSS1808	1800	800	720	619	637
	VSSS2008	2000	800	720	633	652
	VSAS1006	1000	600	720	415	427
	VSAS1206	1200	600	720	422	434
	VSAS1406	1400	600	720	435	448
	VSAS1606	1600	600	720	495	510
	VSAS1806	1800	600	720	498	514
	VSAS2006	2000	600	720	512	527
	VSAS1008	1000	800	720	436	436
	VSAS1208	1200	800	720	438	453
	VSAS1408	1400	800	720	449	464
	VSAS1608	1600	800	720	530	548
	VSAS1808	1800	800	720	532	550
	VSAS2008	2000	800	720	546	565

Single Add on Module













Vega six person back to back desk shown in walnut with S4 screen.

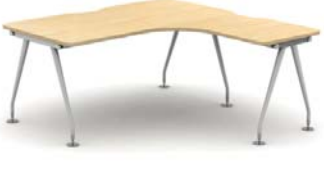

Vega six person back to back desk shown in sand zebrano with S3 tool rail.



Description	Code	W	D	H	Price £		
					A	B	
Top Options: A = Beech, Maple, Oak, White B = Cherry, Hacienda Black, Walnut, Zebrano							
Frame Options Suffix Code: S = Silver W = White							
	Rectangular desk	VD08	800	800	720	414	427
		VD10	1000	800	720	436	451
		VD12	1200	800	720	438	453
		VD14	1400	800	720	449	464
		VD16	1600	800	720	512	530
		VD18	1800	800	720	514	532
		VD20	2000	800	720	528	547
	Flare desk	VF12L/R	1200	800-900	720	479	498
	RH illustrated	VF14L/R	1400	800-900	720	496	515
		VF16L/R	1600	800-900	720	535	554
		VF18L/R	1800	800-900	720	558	581
	Core workstation	VC16L/R	1600	1200	720	690	712
	Ends are 800d x 600d RH illustrated	VC18L/R	1800	1200	720	723	748
	Core workstation	VCB16L/R	1600	1200	720	577	599
	With pedestal bracket Ends are 800d x 600d RH illustrated	VCB18L/R	1800	1200	720	610	635
	Radial workstation	VW161686L/R	1600	1600	720	737	764
Ends are 800d x 600d RH illustrated							
	Radial workstation	VWSP161686L/R	1600	1600	720	610	637
For supporting pedestal (Not included) Ends are 800d x 600d RH illustrated							

Description	Code	W	D	H	Price £		
					A	B	
Top Options: A = Beech, Maple, Oak, White B = Cherry, Hacienda Black, Walnut, Zebrano							
Frame Options Suffix Code: S = Silver W = White							
	Return desk	VR10F	1000	600	720	409	421
	Freestanding	VR12F	1200	600	720	416	428
		VR14F	1400	600	720	429	442
		VR16F	1600	600	720	471	486
	Return desk	VR10C	1000	600	720	377	389
	Connecting	VR12C	1200	600	720	384	396
		VR14C	1400	600	720	397	410
		VR16C	1600	600	720	439	454
	120° Delta workstation	V1206	1115	1115	720	576	601
	1115 x 1115 x 600 x 600 1115 x 1115 x 800 x 800	V1208	1115	1115	720	603	629
	Delta cluster	V3WSD1206	1115	1115	720	1689	1764
	1115 x 1115 x 600 x 600 1115 x 1115 x 800 x 800	V3WSD1208	1115	1115	720	1794	1872









Refer to page 94 for modular Vega conference table options













Vega six person back to back desk shown in white with S4 screen.





Description	Code	W	D	H	Price £	A	B	C
Top Options: A = Beech, Maple, Oak, White B = Cherry, Hacienda Black, Walnut, Zebrano. C = Glass in Black, White or Frosted								
Desk tops	VDT08	800	800	25	118	131	POA	
	VDT10	1000	800	25	140	155	POA	
	VDT12	1200	800	25	142	157	POA	
	VDT14	1400	800	25	145	160	POA	
	VDT16	1600	800	25	174	192	POA	
	VDT18	1800	800	25	176	194	POA	
	VDT20	2000	800	25	190	209	POA	
Flare tops	VFT12L/R	1200	800-900	25	183	202	-	
	VFT14L/R	1400	800-900	25	192	211	-	
	VFT16L/R	1600	800-900	25	197	216	-	
	VFT18L/R	1800	800-900	25	220	243	-	
Core tops	VCT16L/R	1600	1200	25	225	247	-	
	VCT18L/R	1800	1200	25	258	283	-	
Radial tops	VLT16L/R	1600	1600	25	272	299	-	
Delta tops	VCC1206	1115	600	25	249	274	-	
	VCC1208	1115	800	25	264	290	-	
Return tops	VRT08	800	600	25	104	114	-	
	VRT10	1000	600	25	125	137	-	
	VRT12	1200	600	25	132	144	-	
	VRT14	1400	600	25	137	150	-	
	VRT16	1600	600	25	145	160	-	
	VRT18	1800	600	25	148	164	-	
	VRT20	2000	600	25	162	177	-	
Modesty panels	VM08	800	300	18	111	123	-	
	VM10	1000	300	18	116	128	-	
	VM12	1200	300	18	122	134	-	
	VM14	1400	300	18	128	140	-	
	VM16	1600	300	18	133	146	-	
	VM18	1800	300	18	138	151	-	
	VM20	2000	300	18	143	158	-	

Description	Code	W	D	H	Price £
Frame Options Suffix Code: S = Silver W = White					
 Single post leg	VSL			720-760	73
 600 Leg	V6L			720-760	105
 800 Leg	V8L			720-760	111
 1250 End/Shared leg Illustrated	V12L			720-760	164
 1250 Intermediate leg	V12IL			720-760	175
 1650 End/Shared leg	V16L			720-760	184
 1650 Intermediate leg Illustrated	V16IL			720-760	198
 Telescopic beam	Long VLTB Medium VMTB Short VSTB	1410-2000 1210-1400 800-1200			58 41 37
 Mobile conversion kit	Set of 4 castors VMCC4 Set of 2 castors VMCC2 Individual castor VMCC1				45 23 11

Description	Code	W	D	H	Price £
Frame Options Suffix Code: S = Silver W = White					
 Leg end cap set For use on legs without telescopic beams	VBT				22
 Telescopic double cable tray	Large VLTDCCT Small VSTDCT	1410-2000 900-1400	250 250		104 81
 Telescopic single cable tray	Large VLTSCCT Small VSTSCCT	1410-2000 900-1400	150 150		85 67
 Deep cable tray hanger set Positions tray 161mm from the underside of desk tops on back to back desks, 170mm on single side desks	VLCTH			161/170	20
 Shallow cable tray hanger set Positions tray 97mm from the underside of desk tops on back to back desks, 106mm on single side desks	VSCTH			97/106	20
 Fit anywhere tray hanger bracket For use when cable trays need to be fitted to the desk top.	VFACTH			129	20
 Double cable tray end cap set	VDCTEBP				15
 Single cable tray end cap set	VSCTEBP				15
 800 Connecting return inner bracket	VCRIB8				78
 600 Connecting return inner bracket	VCRIB6				73
 Sliding top kit For 800d tops VSTK For 600d tops VSTK6					49 49
 Height adjustable kit For 800d tops VHAK8 For 600d tops VHAK6 Allows adjustment from 720h to 840h					156 156
 Single side cable tray bracket kit For use when sharing 600 / 800 legs	VSSCTHC				24

2 Person Core with Returns 1600 x 1200 with 1200 x 600 returns



Qty	Code	Description	Price £	
			A	B
Top Options: A = Beech, Maple, Oak, White B = Cherry, Hacienda Black, Walnut, Zebrano				
2	O6L	600 Leg	140	140
2	O8L	800 Leg	154	154
2	O6A	Support arm	46	46
1	O4P1050	4 Way post 1050	95	95
5	O4P1450	4 Way post 1450	640	640
2	OIPC	Inline leg to post connector	70	70
4	OOPC	Offset leg to post connector	140	140
2	OITCS	Inline top to leg connector set	144	144
4	OOTCS	Offset top to leg connector set	224	224
6	OMRB	Top to management rail bracket set	216	216
16	OCT4	400 Cable tray	432	432
1	OBSS416R	1600 x 450 return base panel	401	401
2	OBST412S	1200 x 450 inline base panel	554	554
2	OBST412R	1200 x 450 return base panel	554	554
2	OTST412S	1200 x 400 inline top panel	658	658
2	OTST412R	1200 x 400 return top panel	658	658
2	ORT12	1200 x 600 return top	264	288
2	OCT16L/R	1600 x 1200 x 800 x 600 core top	450	494
Total			5840	5908*

3 Person Delta Cluster 1000 x 1000 x 600 x 600



Qty	Code	Description	Price £	
			A	B
Top Options: A = Beech, Maple, Oak, White B = Cherry, Hacienda Black, Walnut, Zebrano				
6	O6L	600 Leg	420	420
1	O3P1050	3 Way post 1050	95	95
3	O4P1050	4 Way post 1050	285	285
6	OOPC	Offset leg to post connector	210	210
6	OOTCS	Offset top to leg connector set	336	336
3	OMRB	Top to management rail bracket set	108	108
3	OBST410S	1000 x 450 inline base panel	804	804
3	OCD106	1000 x 1000 x 600 x 600 delta top	747	822
Total			3005	3080*



4 Person Back to Back Cluster 1600 x 800



Qty	Code	Description	Price £	
			A	B
Top Options: A = Beech, Maple, Oak, White B = Cherry, Hacienda Black, Walnut, Zebrano				
6	O8L	800 Leg	462	462
3	O4P1050	4 Way post 1050	285	285
2	OIPC	Inline leg to post connector	70	70
4	OOPC	Offset leg to post connector	140	140
2	OITCL	Large inline top to leg connector set	158	158
4	OOTCL	Large offset top to leg connector set	248	248
4	VLTB	Long beams 1400-2000	232	232
4	OMRB	Top to management rail bracket set	144	144
12	OCT4	400 Cable tray	324	324
2	OBST416S	1600 x 450 inline base panel	718	718
4	ODT16	1600 x 800 desk top	696	768
Total			3477	3549*



















*Prices based on A band fabric

Alto 2 person back to back core workstation shown in romana cherry.



Description	Code	W	D	H	Price £	
					A	B
Top Options: A = Beech, Maple, Oak, White B = Cherry, Hacienda Black, Walnut, Zebrano						
Desk tops	ODT06	600	800	25	104	114
	ODT08	800	800	25	118	131
	ODT10	1000	800	25	140	155
	ODT12	1200	800	25	142	157
	ODT14	1400	800	25	145	160
	ODT16	1600	800	25	174	192
	ODT18	1800	800	25	176	194
	ODT20	2000	800	25	190	209
Flare tops	OFT12L/R	1200	800-900	25	183	202
	OFT14L/R	1400	800-900	25	192	211
	OFT16L/R	1600	800-900	25	197	216
	OFT18L/R	1800	800-900	25	220	243
	OFT20L/R	2000	800-900	25	235	258
Core tops	OCT16L/R	1600	1200	25	225	247
	OCT18L/R	1800	1200	25	258	283
Radial tops	OLT16L/R	1600	1600	25	272	299
Delta tops	OCD106	1000	600	25	249	274
	OCD108	1000	800	25	264	290
Return tops	ORT06	600	600	25	96	105
	ORT08	800	600	25	104	114
	ORT10	1000	600	25	125	137
	ORT12	1200	600	25	132	144
	ORT14	1400	600	25	137	150
	ORT16	1600	600	25	145	160
	ORT18	1800	600	25	148	164
	ORT20	2000	600	25	162	177



Description	Code	W	H	Price £	Description	Code	W	H	Price £																																																																																					
 <p>3 Way post</p>	03P1050	80ø	1050	95	 <p>Small inline top to leg connector set For use with 800-1200w tops One set per leg specify where leg is shared between 2 tops</p>	OITCS			72																																																																																					
	03P1200	80ø	1200	111																																																																																										
	03P1450	80ø	1450	128																																																																																										
	03P1600	80ø	1600	143																																																																																										
	03P1850	80ø	1850	153																																																																																										
	03P2000	80ø	2000	165																																																																																										
 <p>4 Way post</p>	04P1050	80ø	1050	95	 <p>Small offset top to leg connector set For use with 800-1200w tops One set per leg specify where leg is at the end of run/top</p>	OOTCS			56																																																																																					
	04P1200	80ø	1200	111																																																																																										
	04P1450	80ø	1450	128																																																																																										
	04P1600	80ø	1600	143																																																																																										
	04P1850	80ø	1850	153																																																																																										
	04P2000	80ø	2000	165																																																																																										
600 Leg (non handed)	O6L			70	 <p>Large inline top to leg connector set For use with front beam on 1400-2000w tops</p>	OITCL			79																																																																																					
800 Leg (non handed)	O8L			77						Support arm	O6A	600		23	 <p>Large offset top to leg connector set For use with front beam on 1400-2000w tops</p>	OOTCL				62	O8A	800		23	Inline leg to post connector Specify when leg is shared between 2 tops	OIPC			35	 <p>Top to management rail bracket set One set per edge next to management rail e.g. One set per rectangle/flare, two sets per core/radial</p>	OMRB				36	Offset leg to post connector Specify where leg is at the end of run/top non handed	OOPC			35	Post cable management clip	OCCM			11	 <p>Hook on cable tray</p>	OCT4	400			27						 <p>Telescopic beam</p>													Long			VLTB	1410-2000	58							Medium			VMTB	1210-1400	41							Short
Support arm	O6A	600		23	 <p>Large offset top to leg connector set For use with front beam on 1400-2000w tops</p>	OOTCL					62																																																																																			
	O8A	800		23						Inline leg to post connector Specify when leg is shared between 2 tops		OIPC			35	 <p>Top to management rail bracket set One set per edge next to management rail e.g. One set per rectangle/flare, two sets per core/radial</p>	OMRB				36	Offset leg to post connector Specify where leg is at the end of run/top non handed	OOPC			35	Post cable management clip	OCCM			11	 <p>Hook on cable tray</p>	OCT4	400			27						 <p>Telescopic beam</p>													Long			VLTB	1410-2000	58							Medium			VMTB	1210-1400	41							Short			VSTB	800-1200	37									
Inline leg to post connector Specify when leg is shared between 2 tops	OIPC			35	 <p>Top to management rail bracket set One set per edge next to management rail e.g. One set per rectangle/flare, two sets per core/radial</p>	OMRB				36																																																																																				
Offset leg to post connector Specify where leg is at the end of run/top non handed	OOPC			35							Post cable management clip	OCCM			11	 <p>Hook on cable tray</p>	OCT4	400			27						 <p>Telescopic beam</p>													Long			VLTB	1410-2000	58							Medium			VMTB	1210-1400	41							Short			VSTB	800-1200	37																									
Post cable management clip	OCCM			11	 <p>Hook on cable tray</p>	OCT4	400			27																																																																																				
					 <p>Telescopic beam</p>																																																																																									
						Long			VLTB	1410-2000	58																																																																																			
						Medium			VMTB	1210-1400	41																																																																																			
						Short			VSTB	800-1200	37																																																																																			

Base Panel with Management Rail and Top Toolrail



Description	Code	H	W	Price £		
				A	B	C
Suffix order code to select material:						
A	Camira Cara,					
B	Camira Lucia, Phoenix, Racer					
C	Acrylic					
800 Inline	OBST408S	450	720	237	251	304
800 Return	OBST408R	450	745	237	251	304
1000 Inline	OBST410S	450	920	268	287	344
1000 Return	OBST410R	450	945	268	287	344
1200 Inline	OBST412S	450	1120	277	298	359
1200 Return	OBST412R	450	1145	277	298	359
1400 Inline	OBST414S	450	1320	329	359	432
1400 Return	OBST414R	450	1345	329	359	432
1600 Inline	OBST416S	450	1520	359	391	468
1600 Return	OBST416R	450	1545	359	391	468
1800 Inline	OBST418S	450	1720	385	421	499
1800 Return	OBST418R	450	1745	385	421	499
2000 Inline	OBST420S	450	1920	417	448	535
2000 Return	OBST420R	450	1945	417	448	535
800 Inline	OBST608S	600	720	268	287	340
800 Return	OBST608R	600	745	268	287	340
1000 Inline	OBST610S	600	920	298	318	381
1000 Return	OBST610R	600	945	298	318	381
1200 Inline	OBST612S	600	1120	304	329	396
1200 Return	OBST612R	600	1145	304	329	396
1400 Inline	OBST614S	600	1320	365	396	473
1400 Return	OBST614R	600	1345	365	396	473
1600 Inline	OBST616S	600	1520	401	437	525
1600 Return	OBST616R	600	1545	401	437	525
1800 Inline	OBST618S	600	1720	432	462	544
1800 Return	OBST618R	600	1745	432	462	544
2000 Inline	OBST620S	600	1920	462	493	586
2000 Return	OBST620R	600	1945	462	493	586
800 Inline	OTST408S	400	720	220	232	277
800 Return	OTST408R	400	745	220	232	277
1000 Inline	OTST410S	400	920	242	251	304
1000 Return	OTST410R	400	945	242	251	304
1200 Inline	OTST412S	400	1120	268	277	329
1200 Return	OTST412R	400	1145	268	277	329
1400 Inline	OTST414S	400	1320	283	298	359
1400 Return	OTST414R	400	1345	283	298	359
1600 Inline	OTST416S	400	1520	304	318	381
1600 Return	OTST416R	400	1545	304	318	381
1800 Inline	OTST418S	400	1720	324	344	406
1800 Return	OTST418R	400	1745	324	344	406
2000 Inline	OTST420S	400	1920	350	365	437
2000 Return	OTST420R	400	1945	350	365	437

Top Panel with Top Toolrail



Base Panel with Management Rail and Top Slatwall



Description	Code	H	W	Price £		
				A	B	C
Suffix order code to select material:						
A	Camira Cara,					
B	Camira Lucia, Phoenix, Racer					
C	Acrylic					
800 Inline	OBSS408S	450	720	273	287	324
800 Return	OBSS408R	450	745	273	287	324
1000 Inline	OBSS410S	450	920	304	318	381
1000 Return	OBSS410R	450	945	304	318	381
1200 Inline	OBSS412S	450	1120	359	381	458
1200 Return	OBSS412R	450	1145	359	381	458
1400 Inline	OBSS414S	450	1320	385	406	493
1400 Return	OBSS414R	450	1345	385	406	493
1600 Inline	OBSS416S	450	1520	401	426	509
1600 Return	OBSS416R	450	1545	401	426	509
1800 Inline	OBSS418S	450	1720	432	452	540
1800 Return	OBSS418R	450	1745	432	452	540
2000 Inline	OBSS420S	450	1920	499	525	627
2000 Return	OBSS420R	450	1945	499	525	627
800 Inline	OBSS608S	600	720	283	298	381
800 Return	OBSS608R	600	745	283	298	381
1000 Inline	OBSS610S	600	920	314	334	401
1000 Return	OBSS610R	600	945	314	334	401
1200 Inline	OBSS612S	600	1120	376	396	473
1200 Return	OBSS612R	600	1145	376	396	473
1400 Inline	OBSS614S	600	1320	401	426	515
1400 Return	OBSS614R	600	1345	401	426	515
1600 Inline	OBSS616S	600	1520	421	448	535
1600 Return	OBSS616R	600	1545	421	448	535
1800 Inline	OBSS618S	600	1720	452	504	602
1800 Return	OBSS618R	600	1745	452	504	602
2000 Inline	OBSS620S	600	1920	519	581	694
2000 Return	OBSS620R	600	1945	519	581	694
800 Inline	OTSS408S	400	720	242	251	304
800 Return	OTSS408R	400	745	242	251	304
1000 Inline	OTSS410S	400	920	268	283	340
1000 Return	OTSS410R	400	945	268	283	340
1200 Inline	OTSS412S	400	1120	287	304	365
1200 Return	OTSS412R	400	1145	287	304	365
1400 Inline	OTSS414S	400	1320	309	324	391
1400 Return	OTSS414R	400	1345	309	324	391
1600 Inline	OTSS416S	400	1520	340	354	426
1600 Return	OTSS416R	400	1545	340	354	426
1800 Inline	OTSS418S	400	1720	359	376	448
1800 Return	OTSS418R	400	1745	359	376	448
2000 Inline	OTSS420S	400	1920	381	401	478
2000 Return	OTSS420R	400	1945	381	401	478

Top Panel with Top Slatwall

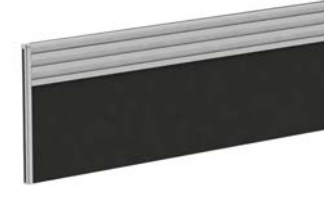

Alto 4 person back to back workstation with post mounted shelves shown in oak.



Alto 4 person back to back workstation with post mounted storage shown in oak.



Post Mounted Shelf



Post Mounted Storage



Description	Code	W	D	H	Price £	
					A	B
Top Options: A = Beech, Maple, Oak, White B = Cherry, Hacienda Black, Walnut, Zebrano						
Back to back shelving	03SSB10	1000	600	25	435	443
	03SSB12	1200	600	25	485	495
	03SSB14	1400	600	25	539	550
	03SSB16	1600	600	25	595	608
	03SSB18	1800	600	25	659	673
	03SSB20	2000	600	25	716	731
Single side shelving	03SSS10	1000	300	25	279	285
	03SSS12	1200	300	25	307	314
	03SSS14	1400	300	25	342	349
	03SSS16	1600	300	25	380	388
	03SSS18	1800	300	25	421	431
	03SSS20	2000	300	25	456	466
Back to back storage	03SCB10	1000	600	425	662	684
	03SCB12	1200	600	425	729	753
	03SCB14	1400	600	425	795	822
	03SCB16	1600	600	425	871	901
	03SCB18	1800	600	425	954	987
	03SCB20	2000	600	425	1030	1066
Single side storage	03SCS10	1000	300	425	466	482
	03SCS12	1200	300	425	504	521
	03SCS14	1400	300	425	548	568
	03SCS16	1600	300	425	603	623
	03SCS18	1800	300	425	656	680
	03SCS20	2000	300	425	703	729
Storage system post	04P1730	800		1730	165	-
Must be used when specifying the above storage options. Drilled to locate and secure storage.						

Screen Mounted Shelf



Description	Code	W	D	H	Price £	
					A	B
Options: A = Beech, Maple, Oak, White B = Cherry, Hacienda Black, Walnut, Zebrano						
OSD08		800	250	400	188	206
OSD10		1000	250	400	196	214
OSD12		1200	250	400	254	276
OSD14		1400	250	400	278	304
OSD16		1600	250	400	286	312
OSD18		1800	250	400	299	327
OSD20		2000	250	400	316	350

2 Person Back to Back Configuration



Description	Code	W	D	H	Price £	
Top Options: A = Beech, Maple, Oak, White B = Cherry, Hacienda Black, Walnut, Zebrano P = Ports, N = No Ports, S = Scallop (£30 surcharge per top) Amend code as required					A	B
Frame Options Suffix Code: S = Silver W = White						
Includes telescopic cable tray	Y2P2PB126	1200	1250	730	647	667
Integral sliding tops	Y2P2PB146	1400	1250	730	659	681
	Y2P2PB166	1600	1250	730	730	756
	Y2P2PB186	1800	1250	730	738	764
	Y2P2PB206	2000	1250	730	788	820
	Y2P2PB128	1200	1650	730	697	723
	Y2P2PB148	1400	1650	730	701	727
	Y2P2PB168	1600	1650	730	780	810
	Y2P2PB188	1800	1650	730	786	818
	Y2P2PB208	2000	1650	730	840	870

6 Person Back to Back Configuration



Description	Code	W	D	H	Price £	
Top Options: A = Beech, Maple, Oak, White B = Cherry, Hacienda Black, Walnut, Zebrano P = Ports, N = No Ports, S = Scallop (£30 surcharge per top) Amend code as required					A	B
Frame Options Suffix Code: S = Silver W = White						
Includes telescopic cable tray	Y2P6PB126	1200	1250	730	1727	1787
Integral sliding tops	Y2P6PB146	1400	1250	730	1763	1829
	Y2P6PB166	1600	1250	730	1976	2054
	Y2P6PB186	1800	1250	730	2000	2078
	Y2P6PB206	2000	1250	730	2150	2246
	Y2P6PB128	1200	1650	730	1825	1903
	Y2P6PB148	1400	1650	730	1837	1915
	Y2P6PB168	1600	1650	730	2074	2164
	Y2P6PB188	1800	1650	730	2092	2188
	Y2P6PB208	2000	1650	730	2254	2344

4 Person Back to Back Configuration



Description	Code	W	D	H	Price £	
Top Options: A = Beech, Maple, Oak, White B = Cherry, Hacienda Black, Walnut, Zebrano P = Ports, N = No Ports, S = Scallop (£30 surcharge per top) Amend code as required					A	B
Frame Options Suffix Code: S = Silver W = White						
Includes telescopic cable tray	Y2P4PB126	1200	1250	730	1187	1227
Integral sliding tops	Y2P4PB146	1400	1250	730	1211	1255
	Y2P4PB166	1600	1250	730	1353	1405
	Y2P4PB186	1800	1250	730	1369	1421
	Y2P4PB206	2000	1250	730	1469	1533
	Y2P4PB128	1200	1650	730	1261	1313
	Y2P4PB148	1400	1650	730	1269	1321
	Y2P4PB168	1600	1650	730	1427	1487
	Y2P4PB188	1800	1650	730	1439	1503
	Y2P4PB208	2000	1650	730	1547	1607

8 Person Back to Back Configuration

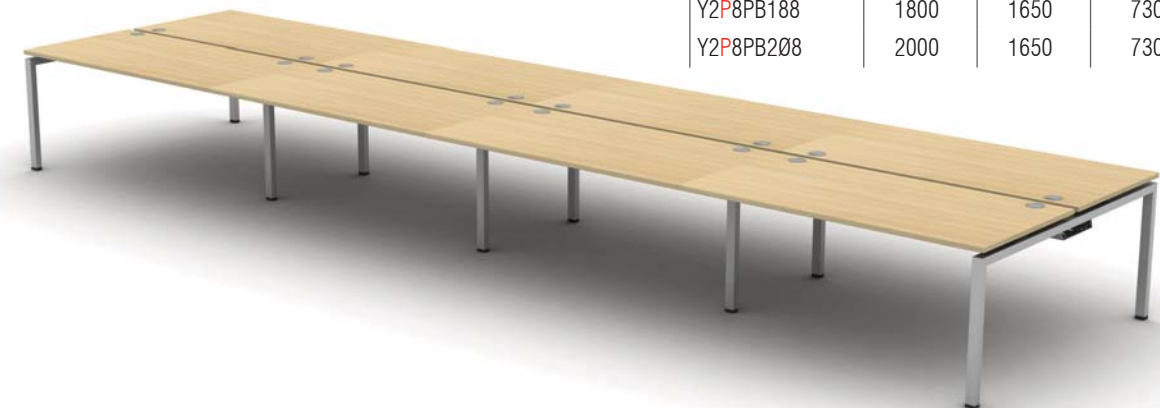

Description	Code	W	D	H	Price £	
Top Options: A = Beech, Maple, Oak, White B = Cherry, Hacienda Black, Walnut, Zebrano P = Ports, N = No Ports, S = Scallop (£30 surcharge per top) Amend code as required					A	B
Frame Options Suffix Code: S = Silver W = White						
Includes telescopic cable tray	Y2P8PB126	1200	1250	730	2267	2347
Integral sliding tops	Y2P8PB146	1400	1250	730	2315	2403
	Y2P8PB166	1600	1250	730	2599	2703
	Y2P8PB186	1800	1250	730	2631	2735
	Y2P8PB206	2000	1250	730	2831	2959
	Y2P8PB128	1200	1650	730	2389	2493
	Y2P8PB148	1400	1650	730	2405	2509
	Y2P8PB168	1600	1650	730	2721	2841
	Y2P8PB188	1800	1650	730	2745	2873
	Y2P8PB208	2000	1650	730	2961	3081

Back to Back Starter Module



Back to Back Add on Module



Soho² four person back to back desk shown in romana cherry with S4 screen with slatwall. Touch chairs shown.



Description	Code	W	D	H	Price £	
					A	B
Top Options: A = Beech, Maple, Oak, White B = Cherry, Hacienda Black, Walnut, Zebrano P = Ports, N = No Ports, S = Scallop (£30 surcharge per top) Amend code as required						
Frame Options Suffix Code: S = Silver W = White						
Includes telescopic cable tray	Y2PSUB106	1000	1250	730	611	629
Integral sliding tops	Y2PSUB126	1200	1250	730	647	667
	Y2PSUB146	1400	1250	730	659	681
	Y2PSUB166	1600	1250	730	730	756
	Y2PSUB186	1800	1250	730	738	764
	Y2PSUB206	2000	1250	730	788	820
	Y2PSUB108	1000	1650	730	667	693
	Y2PSUB128	1200	1650	730	697	723
	Y2PSUB148	1400	1650	730	701	727
	Y2PSUB168	1600	1650	730	780	810
	Y2PSUB188	1800	1650	730	786	818
	Y2PSUB208	2000	1650	730	840	870
	Y2PAOB106	1000	1250	730	504	522
	Y2PAOB126	1200	1250	730	540	560
	Y2PAOB146	1400	1250	730	552	574
	Y2PAOB166	1600	1250	730	623	649
	Y2PAOB186	1800	1250	730	631	657
	Y2PAOB206	2000	1250	730	681	713
	Y2PAOB108	1000	1650	730	534	560
	Y2PAOB128	1200	1650	730	564	590
	Y2PAOB148	1400	1650	730	568	594
	Y2PAOB168	1600	1650	730	647	677
	Y2PAOB188	1800	1650	730	653	685
	Y2PAOB208	2000	1650	730	707	737

Single Side Starter Module









Single Side Add on Module







Description	Code	W	D	H	Price £	
					A	B
Top Options: A = Beech, Maple, Oak, White B = Cherry, Hacienda Black, Walnut, Zebrano P = Ports, N = No Ports, S = Scallop (£30 surcharge per top) Amend code as required						
Frame Options Suffix Code: S = Silver W = White						
Includes telescopic cable tray	Y2PSUS108	1000	800	730	420	433
Integral sliding tops	Y2PSUS128	1200	800	730	435	448
	Y2PSUS148	1400	800	730	437	450
	Y2PSUS168	1600	800	730	483	498
	Y2PSUS188	1800	800	730	486	502
	Y2PSUS208	2000	800	730	513	528
	Y2PAOS108	1000	800	730	357	370
	Y2PAOS128	1200	800	730	372	385
	Y2PAOS148	1400	800	730	374	387
	Y2PAOS168	1600	800	730	420	435
	Y2PAOS188	1800	800	730	423	439
	Y2PAOS208	2000	800	730	450	465

Soho² six person back to back desks shown in sand zebrano with S2 screens. Touch chairs and steel high mobile pedestals shown.



Description	Code	W	D	H	Price £	
Top Options: A = Beech, Maple, Oak, White B = Cherry, Hacienda Black, Walnut, Zebrano P = Ports, N = No Ports, S = Scallop (£30 surcharge per top) Amend code as required Frame Options Suffix Code: S = Silver W = White					A	B
 Rectangular desk	Y2PDSK088	800	800	730	313	322
Integral sliding top	Y2PDSK108	1000	800	730	333	346
	Y2PDSK128	1200	800	730	348	361
	Y2PDSK148	1400	800	730	350	363
	Y2PDSK168	1600	800	730	378	393
	Y2PDSK188	1800	800	730	381	397
	Y2PDSK208	2000	800	730	408	423
 Flare workstation	Y2PFLA12L/R	1200	800-900	730	387	402
RH illustrated	Y2PFLA14L/R	1400	800-900	730	397	412
Integral sliding top	Y2PFLA16L/R	1600	800-900	730	402	418
	Y2PFLA18L/R	1800	800-900	730	426	445
 Core workstation	Y2PCOR16L/R	1600	1200	730	580	599
Ends are 800d x 600d RH illustrated	Y2PCOR18L/R	1800	1200	730	613	635
 Core workstation With pedestal bracket	Y2PCRB16L/R	1600	1200	730	445	464
Ends are 800d x 600d RH illustrated	Y2PCRB18L/R	1800	1200	730	478	500
 Radial workstation	Y2PLDF16L/R	1600	1600	730	637	662
Ends are 800d x 600d RH illustrated						
 Radial workstation For supporting pedestal (Not included)	Y2PLDS16L/R	1600	1600	730	476	501
Ends are 800d x 600d RH illustrated						

Description	Code	W	D	H	Price £	
Top Options: A = Beech, Maple, Oak, White B = Cherry, Hacienda Black, Walnut, Zebrano P = Ports, N = No Ports, S = Scallop (£30 surcharge per top) Amend code as required Frame Options Suffix Code: S = Silver W = White					A	B
 Return desk	Y2PRNF106	1000	600	730	302	311
Freestanding	Y2PRNF126	1200	600	730	320	330
Integral sliding top	Y2PRNF146	1400	600	730	326	337
	Y2PRNF166	1600	600	730	350	363
	Y2PRNF186	1800	600	730	354	367
	Y2PRNF206	2000	600	730	379	395
 Return desk Connecting	Y2PRNC106	1000	600	730	290	299
	Y2PRNC126	1200	600	730	296	306
	Y2PRNC146	1400	600	730	302	313
	Y2PRNC166	1600	600	730	341	354
	Y2PRNC186	1800	600	730	345	358
	Y2PRNC206	2000	600	730	355	371
 Bow front executive desk	Y2PBFE161	1600	800-1000	730	402	418
Integral sliding top	Y2PBFE181	1800	800-1000	730	426	445
	Y2PBFE201	2000	800-1000	730	454	475
 120° Delta workstation	Y2PDLT116	1115	600	730	595	621
1115 x 1115 x 600 x 600	Y2PDLT118	1115	800	730	626	652
1115 x 1115 x 800 x 800						
 120° Delta workstation	Y2P3DL116	2581	2235	730	1644	1722
1115 x 1115 x 600 x 600	Y2P3DL118	2781	2409	730	1728	1806
1115 x 1115 x 800 x 800						

2 Person Back to Back Configuration



Description	Code	W	D	H	Price £	
					A	B
Top Options: A = Beech, Maple, Oak, White B = Cherry, Hacienda Black, Walnut, Zebrano P = Ports, N = No Ports, S = Scallop (£30 surcharge per top) Amend code as required						
Frame Options Suffix Code: S = Silver W = White						
Includes telescopic cable tray	Y3P2PB126	1200	1250	730	647	667
Integral sliding tops	Y3P2PB146	1400	1250	730	659	681
	Y3P2PB166	1600	1250	730	730	756
	Y3P2PB186	1800	1250	730	738	764
	Y3P2PB206	2000	1250	730	788	820
	Y3P2PB128	1200	1650	730	697	723
	Y3P2PB148	1400	1650	730	701	727
	Y3P2PB168	1600	1650	730	780	810
	Y3P2PB188	1800	1650	730	786	818
	Y3P2PB208	2000	1650	730	840	870

6 Person Back to Back Configuration



Description	Code	W	D	H	Price £	
					A	B
Top Options: A = Beech, Maple, Oak, White B = Cherry, Hacienda Black, Walnut, Zebrano P = Ports, N = No Ports, S = Scallop (£30 surcharge per top) Amend code as required						
Frame Options Suffix Code: S = Silver W = White						
Includes telescopic cable tray	Y3P6PB126	1200	1250	730	1727	1787
Integral sliding tops	Y3P6PB146	1400	1250	730	1763	1829
	Y3P6PB166	1600	1250	730	1976	2054
	Y3P6PB186	1800	1250	730	2000	2078
	Y3P6PB206	2000	1250	730	2150	2246
	Y3P6PB128	1200	1650	730	1825	1903
	Y3P6PB148	1400	1650	730	1837	1915
	Y3P6PB168	1600	1650	730	2074	2164
	Y3P6PB188	1800	1650	730	2092	2188
	Y3P6PB208	2000	1650	730	2254	2344

4 Person Back to Back Configuration



Description	Code	W	D	H	Price £	
					A	B
Top Options: A = Beech, Maple, Oak, White B = Cherry, Hacienda Black, Walnut, Zebrano P = Ports, N = No Ports, S = Scallop (£30 surcharge per top) Amend code as required						
Frame Options Suffix Code: S = Silver W = White						
Includes telescopic cable tray	Y3P4PB126	1200	1250	730	1187	1227
Integral sliding tops	Y3P4PB146	1400	1250	730	1211	1255
	Y3P4PB166	1600	1250	730	1353	1405
	Y3P4PB186	1800	1250	730	1369	1421
	Y3P4PB206	2000	1250	730	1469	1533
	Y3P4PB128	1200	1650	730	1261	1313
	Y3P4PB148	1400	1650	730	1269	1321
	Y3P4PB168	1600	1650	730	1427	1487
	Y3P4PB188	1800	1650	730	1439	1503
	Y3P4PB208	2000	1650	730	1547	1607

8 Person Back to Back Configuration

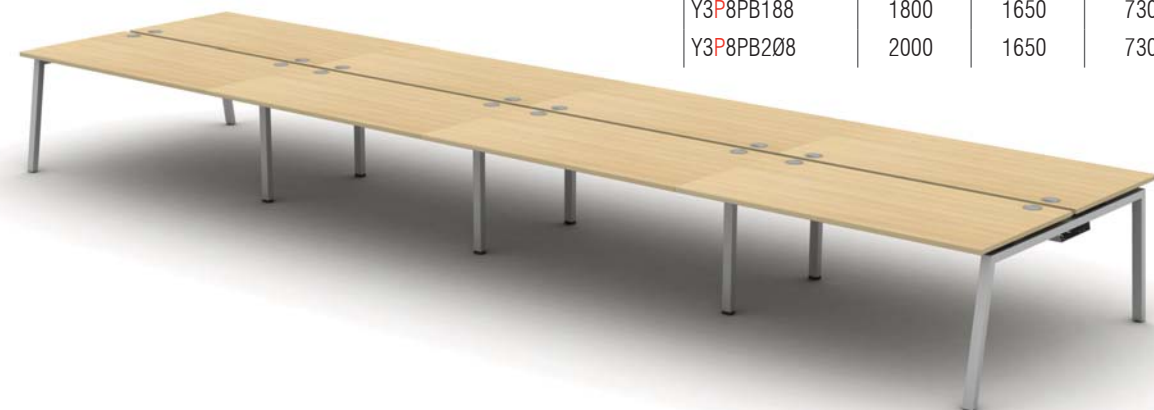

Description	Code	W	D	H	Price £	
					A	B
Top Options: A = Beech, Maple, Oak, White B = Cherry, Hacienda Black, Walnut, Zebrano P = Ports, N = No Ports, S = Scallop (£30 surcharge per top) Amend code as required						
Frame Options Suffix Code: S = Silver W = White						
Includes telescopic cable tray	Y3P8PB126	1200	1250	730	2267	2347
Integral sliding tops	Y3P8PB146	1400	1250	730	2315	2403
	Y3P8PB166	1600	1250	730	2599	2703
	Y3P8PB186	1800	1250	730	2631	2735
	Y3P8PB206	2000	1250	730	2831	2959
	Y3P8PB128	1200	1650	730	2389	2493
	Y3P8PB148	1400	1650	730	2405	2509
	Y3P8PB168	1600	1650	730	2721	2841
	Y3P8PB188	1800	1650	730	2745	2873
	Y3P8PB208	2000	1650	730	2961	3081

Soho³

Back to Back Starter Module



Back to Back Add on Module



Soho³ four person back to back desk shown in romana cherry with S4 screen.



Description	Code	W	D	H	Price £	
					A	B
Top Options: A = Beech, Maple, Oak, White B = Cherry, Hacienda Black, Walnut, Zebrano P = Ports, N = No Ports, S = Scallop (£30 surcharge per top) Amend code as required						
Frame Options Suffix Code: S = Silver W = White						
Includes telescopic cable tray	Y3PSUB106	1000	1250	730	611	629
Integral sliding tops	Y3PSUB126	1200	1250	730	647	667
	Y3PSUB146	1400	1250	730	659	681
	Y3PSUB166	1600	1250	730	730	756
	Y3PSUB186	1800	1250	730	738	764
	Y3PSUB206	2000	1250	730	788	820
	Y3PSUB108	1000	1650	730	667	693
	Y3PSUB128	1200	1650	730	697	723
	Y3PSUB148	1400	1650	730	701	727
	Y3PSUB168	1600	1650	730	780	810
	Y3PSUB188	1800	1650	730	786	818
	Y3PSUB208	2000	1650	730	840	870
	Y3PAOB106	1000	1250	730	504	522
	Y3PAOB126	1200	1250	730	540	560
	Y3PAOB146	1400	1250	730	552	574
	Y3PAOB166	1600	1250	730	623	649
	Y3PAOB186	1800	1250	730	631	657
	Y3PAOB206	2000	1250	730	681	713
	Y3PAOB108	1000	1650	730	534	560
	Y3PAOB128	1200	1650	730	564	590
	Y3PAOB148	1400	1650	730	568	594
	Y3PAOB168	1600	1650	730	647	677
	Y3PAOB188	1800	1650	730	653	685
	Y3PAOB208	2000	1650	730	707	737

Soho³

Single Side Starter Module









Single Side Add on Module







Description	Code	W	D	H	Price £	
					A	B
Top Options: A = Beech, Maple, Oak, White B = Cherry, Hacienda Black, Walnut, Zebrano P = Ports, N = No Ports, S = Scallop (£30 surcharge per top) Amend code as required						
Frame Options Suffix Code: S = Silver W = White						
Includes telescopic cable tray	Y3PSUS108	1000	800	730	420	433
Integral sliding tops	Y3PSUS128	1200	800	730	435	448
	Y3PSUS148	1400	800	730	437	450
	Y3PSUS168	1600	800	730	483	498
	Y3PSUS188	1800	800	730	486	502
	Y3PSUS208	2000	800	730	513	528
	Y3PAOS108	1000	800	730	357	370
	Y3PAOS128	1200	800	730	372	385
	Y3PAOS148	1400	800	730	374	387
	Y3PAOS168	1600	800	730	420	435
	Y3PAOS188	1800	800	730	423	439
	Y3PAOS208	2000	800	730	450	465

Soho³ four person back to back desk shown in romana cherry with S4 screen with slatwall. Touch chairs shown.



Description	Code	W	D	H	Price £		
					A	B	
Top Options: A = Beech, Maple, Oak, White B = Cherry, Hacienda Black, Walnut, Zebrano P = Ports, N = No Ports, S = Scallop (£30 surcharge per top) Amend code as required Frame Options Suffix Code: S = Silver W = White							
	Rectangular desk	Y3PDSK088	800	800	730	313	322
	Integral sliding top	Y3PDSK108	1000	800	730	333	346
		Y3PDSK128	1200	800	730	348	361
		Y3PDSK148	1400	800	730	350	363
		Y3PDSK168	1600	800	730	378	393
		Y3PDSK188	1800	800	730	381	397
		Y3PDSK208	2000	800	730	408	423
	Flare workstation	Y3PFLA12L/R	1200	800-900	730	387	402
	RH illustrated	Y3PFLA14L/R	1400	800-900	730	397	412
	Integral sliding top	Y3PFLA16L/R	1600	800-900	730	402	418
		Y3PFLA18L/R	1800	800-900	730	426	445
	Core workstation	Y3PCOR16L/R	1600	1200	730	580	599
	Ends are 800d x 600d	Y3PCOR18L/R	1800	1200	730	613	635
	RH illustrated						
	Core workstation	Y3PCRB16L/R	1600	1200	730	445	464
	With pedestal bracket	Y3PCRB18L/R	1800	1200	730	478	500
	Ends are 800d x 600d						
	RH illustrated						
	Radial workstation	Y3PLDF16L/R	1600	1600	730	637	662
	Ends are 800d x 600d						
	RH illustrated						
	Radial workstation	Y3PLDS16L/R	1600	1600	730	476	501
	For supporting pedestal						
	(Not included)						
	Ends are 800d x 600d						
	RH illustrated						

Description	Code	W	D	H	Price £		
					A	B	
Top Options: A = Beech, Maple, Oak, White B = Cherry, Hacienda Black, Walnut, Zebrano P = Ports, N = No Ports, S = Scallop (£30 surcharge per top) Amend code as required Frame Options Suffix Code: S = Silver W = White							
	Return desk	Y3PRNF106	1000	600	730	302	311
	Freestanding	Y3PRNF126	1200	600	730	320	330
	Integral sliding top	Y3PRNF146	1400	600	730	326	337
		Y3PRNF166	1600	600	730	350	363
		Y3PRNF186	1800	600	730	354	367
		Y3PRNF206	2000	600	730	379	395
	Return desk	Y3PRNC106	1000	600	730	290	299
	Connecting	Y3PRNC126	1200	600	730	296	306
		Y3PRNC146	1400	600	730	302	313
		Y3PRNC166	1600	600	730	341	354
		Y3PRNC186	1800	600	730	345	358
		Y3PRNC206	2000	600	730	355	371
	Bow front executive desk	Y3PBFE161	1600	800-1000	730	402	418
	Integral sliding top	Y3PBFE181	1800	800-1000	730	426	445
		Y3PBFE201	2000	800-1000	730	454	475
	120° Delta workstation	Y3PDLT116	1115	600	730	595	621
	1115 x 1115 x 600 x 600	Y3PDLT118	1115	800	730	626	652
	1115 x 1115 x 800 x 800						
	120° Delta workstation	Y3P3DL116	2581	2235	730	1644	1722
	1115 x 1115 x 600 x 600	Y3P3DL118	2781	2409	730	1728	1806
	1115 x 1115 x 800 x 800						

Soho Components

Description	Code	W	D	H	Price £
Frame Options Suffix Code: S = Silver W = White					
Soho ² end leg	Y2MLEGEN600	600	60		85
	Y2MLEGEN800	800	60		93
Soho ³ end leg	Y3MLEGEN600	600	60		85
	Y3MLEGEN800	800	60		93
Soho ² shared leg	Y2MLEGSH125	1250	60		123
	Y2MLEGSH165	1650	60		136
Soho ³ shared leg	Y3MLEGSH125	1250	60		123
	Y3MLEGSH165	1650	60		136
Soho ^{2/3} intermediate leg	Y2MLEGIN125	1232	60		139
	Y2MLEGIN165	1632	60		139
Soho ² height adjustable leg kit Each kit provides height adjustability for 1 leg frame Fits the Soho ² leg frame only	Y2MHADJUKIT			720-840	64
Soho height adjustable top kit For single desk or 2 person back to back	YYMSTHAKDSK			730-790	160
For end tops on a 4+ person bench	YYMSTHAKEND			730-790	160
For intermediate tops on a 6+ person bench	YYMSTHAKINT			730-790	160

Soho Components

Description	Code	W	D	H	Price £
Frame Options Suffix Code: S = Silver W = White					
Extra large adjustable beam	YYMBEAM1824	1800-2000	80	60	61
Large adjustable beam	YYMBEAM1218	1200-1800	80	60	46
Small adjustable beam	YYMBEAM0811	800-1100	80	60	34
Beam to beam connector	YYMBM2BMCON				30
3 Way tower leg	YYMLEG3WAYT	120ø		695	108
Pillar leg	YYMLEGPRN60	60ø		695	34
Pedestal support bracket	YYMBKTPDSUP				14
Pedestal to beam support bracket	YYMBKTPD2BM				34
Desk mounted CPU holder Available in silver only Allows mounting of CPU holder to underside of work surface around the Soho beam Sliding top function inoperative when fitted.	YYMCPUHOLDT				78
Soho puntale extension bracket For use with the shared leg bracket	YYMBKTPUNTA				39
Shared leg bracket	YYMBKTSHALG				30



Soho² four person back to back desk shown in sand zebrano with S3 tool rail.

Soho Dealer Panels

Description	Code	W	D	H	Price £
Frame Options Suffix Code: S = Silver W = White					
End dealer panels (each)					
For 600 leg	Y2DPE0600	540		630	130
For 800 leg	Y2DPE0800	740		630	148
For 1250 shared leg	Y2DPE1250	1140		630	200
For 1650 shared leg	Y2DPE1650	1540		630	261
Spine dealer panels (each)					
For 800 wide module	YDPS0800	680		630	158
For 1000 wide module	YDPS1000	880		630	182
For 1200 wide module	YDPS1200	1080		630	202
For 1400 wide module	YDPS1400	1280		630	213
For 1600 wide module	YDPS1600	1480		630	259
For 1800 wide module	YDPS1800	1680		630	343
For 2000 wide module	YDPS2000	1880		630	368



Spine dealer panels suitable for back to back desks only.
Central cable tray required when specifying spine dealer panels

Soho Cable Management

Description	Code	Size	Price £
Double telescopic tray for modules 900 - 1400	YYMCTTSSMDB	250	101
Double telescopic tray for modules 1410 - 2000	YYMCTTSLGDB	250	124
Single telescopic tray for modules 900 - 1400	YYMCTTSSMSG	150	87
Single telescopic tray for modules 1410 - 2000	YYMCTTSLGSG	150	105
Sets include cable tray hangers			
Cable dump kit	YCDK1650 YCDK1250	1650 1250	200 200



Soho Components

Worktops





















Modesty Panels



Description	Code	W	D	H	Price £	
Top Options: A = Beech, Maple, Oak, White B = Cherry, Hacienda Black, Walnut, Zebrano P = Ports, N = No Ports, S = Scallop (£30 surcharge per top) Amend code as required					A	B
Desk tops	YYTPD088	800	800	25	93	102
	YYTPD108	1000	800	25	113	126
	YYTPD128	1200	800	25	116	129
	YYTPD148	1400	800	25	118	131
	YYTPD168	1600	800	25	146	161
	YYTPD188	1800	800	25	149	165
	YYTPD208	2000	800	25	161	176
Flare tops	YYTPF12L/R	1200	800-900	25	155	170
	YYTPF14L/R	1400	800-900	25	165	180
	YYTPF16L/R	1600	800-900	25	170	186
	YYTPW18L/R	1800	800-900	25	194	213
Core tops	YYTPC16L/R	1600	1200	25	199	218
	YYTPC18L/R	1800	1200	25	232	254
Radial tops	YYTPL16L/R	1600	1600	25	244	269
Return tops	YYTPR106	1000	600	25	98	107
	YYTPR126	1200	600	25	104	114
	YYTPR146	1400	600	25	110	121
	YYTPR166	1600	600	25	134	147
	YYTPR186	1800	600	25	138	151
	YYTPR206	2000	600	25	148	164
Delta tops	YYTPE116	1115	600	25	249	275
	YYTPE118	1115	800	25	264	290
(Includes fixing brackets)	YYXMOD083	800		300	57	62
	YYXMOD103	1000		300	65	71
	YYXMOD123	1200		300	76	83
	YYXMOD143	1400		300	80	88
	YYXMOD163	1600		300	84	93
	YYXMOD183	1800		300	90	98
	YYXMOD203	2000		300	94	102

Description	Code	W	D	H	Price £		
					A	B	
Top Options: A = Beech, Maple, Oak, White B = Cherry, Hacienda Black, Walnut, Zebrano							
	Rectangular desk	K2CD08	800	800	720	312	321
		K2CD10	1000	800	720	332	345
		K2CD12	1200	800	720	349	362
		K2CD14	1400	800	720	351	364
		K2CD16	1600	800	720	379	394
		K2CD18	1800	800	720	382	398
	Flare workstation	K2CF12L/R	1200	800-900	720	388	403
	RH illustrated	K2CF14L/R	1400	800-900	720	398	413
		K2CF16L/R	1600	800-900	720	403	419
		K2CF18L/R	1800	800-900	720	427	446
	Core workstation	K2CC16L/R	1600	1200	720	593	612
	Ends are 800d x 600d RH illustrated	K2CC18L/R	1800	1200	720	626	648
	Core workstation	K2CCB16L/R	1600	1200	720	446	465
	With pedestal bracket Ends are 800d x 600d RH illustrated	K2CCB18L/R	1800	1200	720	479	501
	Radial workstation	K2CW161686L/R	1600	1600	720	652	677
	Ends are 800d x 600d RH illustrated						
	Radial workstation	K2CSP161686L/R	1600	1600	720	477	502
	For supporting pedestal (Not included) Ends are 800d x 600d RH illustrated						

Description	Code	W	D	H	Price £		
					A	B	
Top Options: A = Beech, Maple, Oak, White B = Cherry, Hacienda Black, Walnut, Zebrano							
	Return desk	K2CR10F	1000	600	720	303	312
	Freestanding	K2CR12F	1200	600	720	323	333
		K2CR14F	1400	600	720	329	340
		K2CR16F	1600	600	720	353	366
	Return desk	K2CR10C	1000	600	720	303	312
	Connecting	K2CR12C	1200	600	720	309	319
		K2CR14C	1400	600	720	315	326
		K2CR16C	1600	600	720	356	369
	Bow front executive desk	K2CBFE16	1600	800-1000	720	405	423
		K2CBFE18	1800	800-1000	720	442	462
		K2CBFE20	2000	800-1000	720	465	487
	120° Delta workstation	K2C1206	1115	1115	720	621	647
	1115 x 1115 x 600 x 600						
	120° Delta workstation	K2C1208	1115	1115	720	650	676
	1115 x 1115 x 800 x 800						

Description	Code	W	D	H	Price £
 Deep extra large adjustable beam	K2BELX	1800-2000	120	88	90
 Deep large adjustable beam	K2BLX	1200-1800	120	88	73
 Deep small adjustable beam	K2BSX	800-1100	120	88	59
 K2C 800 leg	K2C8LX			695	80
 K2C 600 leg	K2C6LX			695	73
 K2C 800 height settable leg	K2C8HALX			620-820	139
 K2C 600 height settable leg	K2C6HALX			620-820	134
 Beam to beam connector	K2BBCX				29
 K2 connecting plate for C leg	K2C0BCPX				30
 K2 connecting plate for I leg	K20BCPX				30
 3 Way tower leg	K23WTHX	120ø		695	108
 Square tower leg	K25WTHX	120ø		695	108
 Pillar leg	K2MDSL	50ø		695	34
 Pedestal support bracket	K2WPB				14
 Pedestal to beam support bracket	K2PBSBX				49
 Desk mounted CPU holder Allows mounting of CPU holder to underside of work surface around the K2 beam (Suitable for all K2 desks)	TCPU	120-220	N/A	430	78
 K2 puntale extension bracket	K2PUNT				39

Worktops



Desk tops



Flare tops



Core tops



Radial tops



Return tops



Delta tops



Modesty Panels



(Includes fixing brackets)

Description	Code	W	D	H	Price £	
Top Options: A = Beech, Maple, Oak, White B = Cherry, Hacienda Black, Walnut, Zebrano						
					A	B
Desk tops	KDT08	800	800	25	93	102
	KDT10	1000	800	25	113	126
	KDT12	1200	800	25	116	129
	KDT14	1400	800	25	118	131
	KDT16	1600	800	25	146	161
	KDT18	1800	800	25	149	165
Flare tops	KLD12L/R	1200	800-900	25	155	170
	KLD14L/R	1400	800-900	25	165	180
	KLD16L/R	1600	800-900	25	170	186
	KLD18L/R	1800	800-900	25	194	213
Core tops	KWS16L/R	1600	1200	25	199	218
	KWS18L/R	1800	1200	25	232	254
Radial tops	KWS161686L/R	1600	1600	25	244	269
Return tops	KRDT10	1000	600	25	98	107
	KRDT12	1200	600	25	104	114
	KRDT14	1400	600	25	110	121
	KRDT16	1600	600	25	134	147
Delta tops	KCC1206	1115	600	25	249	275
	KCC1208	1115	800	25	264	290
(Includes fixing brackets)	K2M08	800		300	57	62
	K2M10	1000		300	65	71
	K2M12	1200		300	76	83
	K2M14	1400		300	80	88
	K2M16	1600		300	84	93
	K2M18	1800		300	90	98
K2M20	2000		300	94	102	

Description	Code	W	D	H	Price £	
					A	B
Top Options: A = Beech, Maple, Oak, White B = Cherry, Hacienda Black, Walnut, Zebrano						
 Rectangular desk	MOP2D08	800	800	720	200	219
	MOP2D10	1000	800	720	218	241
	MOP2D12	1200	800	720	233	256
	MOP2D14	1400	800	720	250	275
	MOP2D16	1600	800	720	261	286
	MOP2D18	1800	800	720	274	303
 Flare workstation RH illustrated	MOP2F12L/R	1200	800-900	720	251	277
	MOP2F14L/R	1400	800-900	720	268	294
	MOP2F16L/R	1600	800-900	720	281	309
	MOP2F18L/R	1800	800-900	720	306	335
 Core workstation Ends are 800d x 600d RH illustrated	MOP2C16L/R	1600	1200	720	358	394
	MOP2C18L/R	1800	1200	720	373	409
 Radial workstation Ends are 800d x 600d RH illustrated	MOP2W161686L/R	1600	1600	720	397	437
	MOP2W181886L/R	1800	1800	720	457	503
 Return desk	MOP2R10	1000	600	720	199	218
	MOP2R12	1200	600	720	210	232
	MOP2R14	1400	600	720	222	245
	MOP2R16	1600	600	720	235	258
 Bow front executive desk	MOP2BFE16	1600	800-1000	720	287	316
	MOP2BFE18	1800	800-1000	720	311	339
	MOP2BFE20	2000	800-1000	720	324	356

Description	Code	W	D	H	Price £	
					A	B
Top Options: A = Beech, Maple, Oak, White B = Cherry, Hacienda Black, Walnut, Zebrano						
 120° Delta workstation 1115 x 1115 x 600 x 600	MOP21206	1115	1115	720	414	454
					435	478
 120° Delta workstation 1115 x 1115 x 800 x 800	MOP21208	1115	1115	720	435	478
					435	478

For cable trays please refer to page 98



Contrax2 panel end flare desks shown in oak with S4 screen. Touch chairs shown.

Description	Code	W	D	H	Price £	
					A	B
Top Options: A = Beech, Maple, Oak, White B = Cherry, Hacienda Black, Walnut, Zebrano						
Rectangular desk	MOC2D08	800	800	720	200	219
	MOC2D10	1000	800	720	218	241
	MOC2D12	1200	800	720	233	256
	MOC2D14	1400	800	720	250	275
	MOC2D16	1600	800	720	261	286
	MOC2D18	1800	800	720	274	303
Flare workstation RH illustrated	MOC2F12L/R	1200	800-900	720	251	277
	MOC2F14L/R	1400	800-900	720	268	294
	MOC2F16L/R	1600	800-900	720	281	309
	MOC2F18L/R	1800	800-900	720	306	335
Core workstation Ends are 800d x 600d RH illustrated	MOC2C16L/R	1600	1200	720	358	394
	MOC2C18L/R	1800	1200	720	373	409
Radial workstation Ends are 800d x 600d RH illustrated	MOC2W161686L/R	1600	1600	720	397	437
	MOC2W181886L/R	1800	1800	720	457	503
Return desk	MOC2R10	1000	600	720	199	218
	MOC2R12	1200	600	720	210	232
	MOC2R14	1400	600	720	222	245
	MOC2R16	1600	600	720	235	258
Bow front executive desk	MOC2BFE16	1600	800-1000	720	287	316
	MOC2BFE18	1800	800-1000	720	311	342
	MOC2BFE20	2000	800-1000	720	324	356

Description	Code	W	D	H	Price £	
					A	B
Top Options: A = Beech, Maple, Oak, White B = Cherry, Hacienda Black, Walnut, Zebrano						
120° Delta workstation 1115 x 1115 x 600 x 600	MOC21206	1115	1115	720	414	454
120° Delta workstation 1115 x 1115 x 800 x 800	MOC21208	1115	1115	720	435	478

For cable trays please refer to page 98















Contrax2 cantilever flare desks shown in oak with S4 screen. Touch chairs shown.



Description	Code	W	D	H	Price £
38mm Panel Options: Cherry, Walnut, White. Contrasting Modesty / Door Options Available					
Desk with full modesty panel	EDFM18	1800	900	740	1169
	EDFM2Ø	2000	900	740	1225
Desk with 3/4 modesty panel	ED18	1800	900	740	1139
	ED2Ø	2000	900	740	1204
Desk with return unit and full modesty panel (RH illustrated)	ERDFM18L/R	1800	1800	740	1640
	ERDFM2ØL/R	2000	1800	740	1694
Desk with return unit and 3/4 modesty panel (RH illustrated)	ERD18L/R	1800	1800	740	1630
	ERD2ØL/R	2000	1800	740	1678
Credenza	EC2Ø	2000	500	630	1983
Open credenza	EOC2Ø	2000	500	630	1939

Cirrus

Description	Code	W	D	H	Price £
38mm Panel Options: Cherry, Walnut, White. Contrasting Modesty / Door Options Available					
 Desk with open credenza and full modesty panel (RH illustrated)	EDOCFM18L/R EDOCFM20L/R	1800 2000	2000 2000	740 740	2939 2998
 Desk with open credenza and 3/4 modesty panel (RH illustrated)	EDOC18L/R EDOC20L/R	1800 2000	2000 2000	740 740	2928 2977
 Desk with credenza and full modesty panel (RH illustrated)	EDCFM18L/R EDCFM20L/R	1800 2000	2000 2000	740 740	2982 3030
 Desk with credenza and 3/4 modesty panel (RH illustrated)	EDC18L/R EDC20L/R	1800 2000	2000 2000	740 740	2965 3014
 Return unit	ERU	900	600	740	482
 Rectangular meeting table	EMT2010	2000	1000	740	1226
 Meeting table with black / chrome frame / 38mm top	ECMT1808 ECMT2010	1800 2000	800 1000	743 743	1112 1236

Description	Code	W	D	H	Price £	
38mm Panel Options: Cherry, Walnut, White. Contrasting Modesty / Door Options Available						
 Coffee table	ECT0606 ECT1206	600 1200	600 600	420 420	369 450	
 Library module	EL2008 EL1608 EL1208 EL0708	800 800 800 800	350 350 350 350	2026 1626 1226 746	1713 1466 1229 986	
 Double door storage	4 adjustable shelves 3 adjustable shelves 2 adjustable shelves 1 adjustable shelf	EDD200835 EDD160835 EDD120835 EDD070835	800 800 800 800	350 350 350 350	2026 1626 1226 746	924 827 735 590
 Double door storage	4 adjustable shelves 3 adjustable shelves 2 adjustable shelves 1 adjustable shelf	EDD200850 EDD160850 EDD120850 EDD070850	800 800 800 800	500 500 500 500	2026 1626 1226 746	1054 951 844 709
 Double door storage	4 adjustable shelves 3 adjustable shelves 2 adjustable shelves 1 adjustable shelf	EDD201035 EDD161035 EDD121035 EDD071035	1000 1000 1000 1000	350 350 350 350	2026 1626 1226 746	1075 967 876 722
 Double door storage	4 adjustable shelves 3 adjustable shelves 2 adjustable shelves 1 adjustable shelf	EDD201050 EDD161050 EDD121050 EDD071050	1000 1000 1000 1000	500 500 500 500	2026 1626 1226 746	1172 1059 951 809

S1 Desk Mounted Acrylic Screens



Description	Code	W	D	H	Price £
For finish options please see page 167					C
5mm thick acrylic screen	S1A0804	800	5	400	167
	S1A1004	1000	5	400	194
	S1A1204	1200	5	400	220
	S1A1404	1400	5	400	247
	S1A1604	1600	5	400	274
	S1A1804	1800	5	400	301
	S1A2004	2000	5	400	346

S1 Desk Mounted Fabric Screens



Description	Code	W	D	H	Price £				
For finish options please see page 167					A	B	C	D	E
28mm thick fabric wrapped screen	S1F0804	800	28	400	165	175	-	205	295
	S1F1004	1000	28	400	175	187	-	219	334
	S1F1204	1200	28	400	184	199	-	233	373
	S1F1404	1400	28	400	201	218	-	255	418
	S1F1604	1600	28	400	211	230	-	269	457
	S1F1804	1800	28	400	234	255	-	299	509
	S1F2004	2000	28	400	244	267	-	312	548

S1 Acrylic Screen Fixing Brackets

Description	Code	Specification	Price £
Please specify desking range when ordering screen brackets			
Arc / Vega / Soho	SB60	Back to back desking	Included with screen
Arc / Vega / Soho Contrax2 / K2	SB61	Single side desks	Included with screen

S1 Fabric Screen Fixing Brackets

Description	Code	Specification	Price £
Please specify desking range when ordering screen brackets			
Arc / Vega / Soho SB62 not compatible with sliding tops	SB62	Back to back desking	Included with screen
Arc / Vega / Soho / Contrax2 / K2	SBUC	Single side desks	Included with screen



S1 Floor Standing Fabric Screens



Description	Code	W	D	H	Price £				
For finish options please see page 167 Requires fixing to desks /storage for stability					A	B	C	D	E
Rectangular 1200H	S1FR0812	800	25	1200	308	339	-	397	546
	S1FR1012	1000	25	1200	339	376	-	440	632
	S1FR1212	1200	25	1200	369	414	-	484	719
	S1FR1412	1400	25	1200	406	458	-	537	812
	S1FR1612	1600	25	1200	437	495	-	580	898
	S1FR1812	1800	25	1200	474	540	-	631	991
Rectangular 1400H	S1FR0814	800	25	1400	318	348	-	407	-
	S1FR1014	1000	25	1400	350	388	-	454	-
	S1FR1214	1200	25	1400	382	427	-	501	-
	S1FR1414	1400	25	1400	414	467	-	546	-
	S1FR1614	1600	25	1400	447	506	-	591	-
	S1FR1814	1800	25	1400	479	545	-	638	-
Rectangular 1600H	S1FR0816	800	25	1600	334	365	-	426	-
	S1FR1016	1000	25	1600	369	406	-	475	-
	S1FR1216	1200	25	1600	403	448	-	524	-
	S1FR1416	1400	25	1600	444	495	-	580	-
	S1FR1616	1600	25	1600	478	538	-	629	-
	S1FR1816	1800	25	1600	512	579	-	678	-
Rectangular 1800H	S1FR0818	800	25	1800	350	384	-	449	-
	S1FR1018	1000	25	1800	450	517	-	605	-
	S1FR1218	1200	25	1800	469	536	-	626	-
	S1FR1418	1400	25	1800	494	561	-	657	-
	S1FR1618	1600	25	1800	513	580	-	679	-
1 Foot	S1FF	400	200	200	110	-	-	-	-

S2 Desk Mounted Screens

S2 Floor Standing Screens





Description	Code	W	D	H	Price £				
For finish options please see page 167 Includes one linking strip for in line linking as standard Frame Options Suffix Code: S = Silver W = White					A	B	C	D	E
Straight 400H 	S2S0804	800	25	400	155	170	-	199	-
	S2S1004	1000	25	400	166	183	-	214	-
	S2S1204	1200	25	400	170	186	-	218	-
	S2S1404	1400	25	400	187	206	-	241	-
	S2S1604	1600	25	400	188	208	-	243	-
	S2S1804	1800	25	400	204	225	-	263	-
	S2S2004	2000	25	400	221	242	-	283	-
Wave 200 – 400H 	S2W0824	800	25	200 - 400	216	239	-	279	-
	S2W1024	1000	25	200 - 400	224	246	-	288	-
	S2W1224	1200	25	200 - 400	231	256	-	300	-
	S2W1424	1400	25	200 - 400	240	266	-	311	-
	S2W1624	1600	25	200 - 400	246	274	-	320	-
	S2W1824	1800	25	200 - 400	262	293	-	342	-
	S2W2024	2000	25	200 - 400	283	304	-	355	-

Fixing Brackets

Description	Code	Specification	Price £
Please specify desking range when ordering screen brackets			
Arc / Vega / Soho	SBUA	Back to back desking	Included with screen
Arc / Vega / Soho / Contrax2 / K2	SBUC	Single side desks	Included with screen

Link Options for Desk Mounted Screens

Description	Code	W	D	H	Price £
90° Two way link	MO2DLK			400	54
Three way link	MO3DLK			400	54
Delta three way 120° link	MO3DELTADLK			400	54
Four way link	MO4DLK			400	54

Description	Code	W	D	H	Price £				
For finish options please see page 167 2 feet required per screen Frame Options Suffix Code: S = Silver W = White					A	B	C	D	E
Rectangular 1200H 	S2FR0812	800	25	1200	267	309	-	362	-
	S2FR1012	1000	25	1200	290	333	-	389	-
	S2FR1212	1200	25	1200	314	362	-	423	-
	S2FR1412	1400	25	1200	347	394	-	461	-
	S2FR1612	1600	25	1200	371	423	-	495	-
	S2FR1812	1800	25	1200	380	433	-	506	-
	Rectangular 1400H 	S2FR0814	800	25	1400	314	333	-	389
S2FR1014		1000	25	1400	333	356	-	417	-
S2FR1214		1200	25	1400	352	380	-	445	-
S2FR1414		1400	25	1400	380	409	-	478	-
S2FR1614		1600	25	1400	414	447	-	523	-
S2FR1814		1800	25	1400	428	461	-	540	-
Rectangular 1600H 		S2FR0816	800	25	1600	333	352	-	412
	S2FR1016	1000	25	1600	347	367	-	430	-
	S2FR1216	1200	25	1600	367	394	-	461	-
	S2FR1416	1400	25	1600	394	423	-	495	-
	S2FR1616	1600	25	1600	423	456	-	534	-
	S2FR1816	1800	25	1600	442	476	-	557	-
	Rectangular 1800H 	S2FR0818	800	25	1800	404	423	-	495
S2FR1018		1000	25	1800	428	447	-	523	-
S2FR1218		1200	25	1800	452	476	-	557	-
S2FR1418		1400	25	1800	476	509	-	595	-
S2FR1618		1600	25	1800	494	527	-	617	-





Link Options for Floor Standing Screens

Description	Code	W	D	H	Price £
Two way link	MO2FLK12				101
	MO2FLK14				108
	MO2FLK16				112
	MO2FLK18				117
Three way link	MO3FLK12				101
	MO3FLK14				108
	MO3FLK16				112
	MO3FLK18				117
Four way link	MO4FLK12				101
	MO4FLK14				108
	MO4FLK16				112
	MO4FLK18				117
T Foot (1 foot)	MOFF				100





S3 Back to Back Screens

S4 Desk Mounted Screens

Description	Code	W	D	H	Price £				
For finish options please see page 167					A	B	C	D	E
Only suitable for back to back desking									
Frame Options Suffix Code: S = Silver W = White									
 S3 tool rail Available in white or silver	S3S800TR	800	50	120	173	-	-	-	-
	S3S1000TR	1000	50	120	181	-	-	-	-
	S3S1200TR	1200	50	120	190	-	-	-	-
	S3S1400TR	1400	50	120	199	-	-	-	-
	S3S1600TR	1600	50	120	207	-	-	-	-
	S3S1800TR	1800	50	120	215	-	-	-	-
	S3S2000TR	2000	50	120	225	-	-	-	-
	S3S2400TR	2400	50	120	241	-	-	-	-
 Acrylic screen insert 380 Height installed (Tool rail not included)	S3SAP0838	800	5	380	-	-	133	-	-
	S3SAP1038	1000	5	380	-	-	149	-	-
	S3SAP1238	1200	5	380	-	-	166	-	-
	S3SAP1438	1400	5	380	-	-	183	-	-
	S3SAP1638	1600	5	380	-	-	199	-	-
	S3SAP1838	1800	5	380	-	-	216	-	-
	S3SAP2038	2000	5	380	-	-	233	-	-
	S3SAP2438	2400	5	380	-	-	266	-	-
 Mesh screen insert 380 Height installed (Tool rail not included)	S3SMP0838	800	40	380	188	207	-	-	-
	S3SMP1038	1000	40	380	206	227	-	-	-
	S3SMP1238	1200	40	380	222	245	-	-	-
	S3SMP1438	1400	40	380	240	264	-	-	-
	S3SMP1638	1600	40	380	258	283	-	-	-
	S3SMP1838	1800	40	380	274	302	-	-	-
	S3SMP2038	2000	40	380	291	320	-	-	-
	S3SMP2438	2400	40	380	325	358	-	-	-
 Fabric screen insert 380 Height installed (Tool rail not included)	S3SWP0838	800	12	380	179	248	-	350	425
	S3SWP1038	1000	12	380	185	258	-	366	444
	S3SWP1238	1200	12	380	189	261	-	378	458
	S3SWP1438	1400	12	380	198	274	-	397	481
	S3SWP1638	1600	12	380	208	287	-	416	504
	S3SWP1838	1800	12	380	226	313	-	447	541
	S3SWP2038	2000	12	380	245	339	-	478	578
	S3SWP2438	2400	12	380	264	365	-	509	615

Fixing Brackets

Description	Code	Specification	Price £
Please specify desking range when ordering screen brackets			
Arc / Vega	SBUB	Back to back desking	Included with tool rail
Soho	SBUF	Back to back desking	Included with tool rail

Description	Code	W	D	H	Price £				
For finish options please see page 167					A	B	C	D	E
Includes one linking strip for in line linking as standard									
Frame Options Suffix Code: S = Silver W = White									
 Straight 400H	SS0804	800	25	400	199	214	280	250	375
	SS1004	1000	25	400	212	231	300	270	403
	SS1204	1200	25	400	227	245	314	286	427
	SS1404	1400	25	400	238	258	329	302	450
	SS1604	1600	25	400	248	268	334	313	469
	SS1804	1800	25	400	259	280	363	328	490
	SS2004	2000	25	400	272	295	378	345	515
	SS2404	2400	25	400	297	323	407	378	565
 Slatwall 400H	SX0804	800	25	400	244	261	325	305	391
	SX1004	1000	25	400	264	281	350	329	423
	SX1204	1200	25	400	288	306	375	357	460
	SX1404	1400	25	400	309	329	400	384	494
	SX1604	1600	25	400	330	349	415	409	525
	SX1804	1800	25	400	350	372	454	435	559
	SX2004	2000	25	400	373	397	480	464	596
	SX2404	2400	25	400	414	441	524	516	663
 Wave 200 – 400H	SW0824	800	25	200-400	279	302	-	353	512
	SW1024	1000	25	200-400	287	311	-	364	527
	SW1224	1200	25	200-400	319	346	-	405	588
	SW1424	1400	25	200-400	323	350	-	410	594
	SW1624	1600	25	200-400	348	377	-	441	640
	SW1824	1800	25	200-400	378	411	-	481	697
	SW2024	2000	25	200-400	421	453	-	530	769
	SW2424	2400	25	200-400	443	475	-	555	806

Fixing Brackets

Description	Code	Specification	Price £
Please specify desking range when ordering screen brackets			
Arc / Vega / Soho	SBUA	Back to back desking	Included with screen
Arc / Vega / Soho / Contrax2 / K2	SB10	Single side desks	Included with screen

Link Options for Desk Mounted Screens

Description	Code	W	D	H	Price £
90° Two way link	MO2DLK			400	54
Three way link	MO3DLK			400	54
Delta three way 120° link	MO3DELTADLK			400	54
Four way link	MO4DLK			400	54

Screen Accessories

S3 Screens



Description	Code	W	D	H	Price £
Options Suffix Code: S = Silver W = White					
Shelf with fins	MOS3STRSWF06	600	300	190	181
Mounts on top of the tool rail	MOS3STRSWF08	800	300	190	186
	MOS3STRSWF10	1000	300	190	201
	MOS3STRSWF12	1200	300	190	206
	A4 paper tray landscape	MOS3STRPT	315	237	43
Mounts on tool rail	MOS3STRBBW	425	265	195	129
	MOS3STRBBM	175	265	195	65
	MOS3STRBBN	100	265	195	52
Pen pot	MOS3STRPP	92	54	80	52
Mounts on tool rail					

S2 / S4 Screens

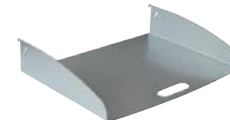
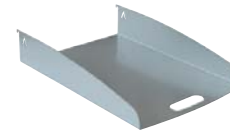

Description	Code	W	D	H	Price £
Options Suffix Code: S = Silver W = White					
A4 paper tray portrait	MOS4ACCA4P	250	330	45	53
A4 paper tray landscape	MOS4ACCA4L	330	250	45	53
3 Tray adaptor landscape	MOS4ACCS3L	255		280	50
3 Tray adaptor portrait	MOS4ACCS3P	345		280	50
Magnetic memo board	MOS4ACCMB	240	210		40
Magnets (Pack of 10 / black, red, blue or white available.)	MOS4ACCMAG	25		25	12
Name plate	MOS4ACCNP	140	40		53
Pen pot	MOS4ACCPJ	80	60	110	46
Shelf	MOS4ACCSH06	600	250	45	78



Meeting Extensions

Contrax2



Description	Code	W	D	H	Price £	
					A	B
Top Options: A = Beech, Maple, Oak, White B = Cherry, Hacienda Black, Walnut, Zebrano						
Workstation extensions						
D-End 800	MOPSC08	800	400	720	183	202
D-End 1200	MOPSC12	1200	450	720	288	317
D-End 1600	MOPSC16	1600	600	720	330	359
D-End 1210	MOPSC1210	1210	450	720	288	317
D-End 1610	MOPSC1610	1610	600	720	330	363
For use with desk mounted dividing screens						
Contrax2 Teardrop extension 120°	MOPCE120	800	1200	720	212	232
Contrax2 Horseshoe extension 250°	MOPCE250	1200	1050	720	249	272

K2 & Soho



D-End extension 800						
K2	K2PSC08	800	400		137	150
Soho	YPSC08	800	400		190	208
D-End extension 1200						
K2	K2PSC12	1200	450		193	212
K2	K2PSC1210	1210	450		193	212
Soho	YPSC12	1250	450		295	324
D-End extension 1600						
K2	K2PSC16	1600	600		238	261
K2	K2PSC1610	1610	600		238	261
Soho	YPSC16	1650	600		335	369
Teardrop extension 120°						
K2	K2PCE120	800	1200	720	330	363
Soho	YPCE120	800	1200	730	379	417
Horseshoe extension 250°						
K2	K2PCE250	1200	1050	720	365	402
Soho	YPCE250	1200	1050	730	417	458

All extensions include connecting brackets

Meeting Extensions

Vega & Arc



Description	Code	W	D	H	Price £	
					A	B
Top Options: A = Beech, Maple, Oak, White B = Cherry, Hacienda Black, Walnut, Zebrano						
Workstation extensions						
D-End 800						
Vega	VPSC08	800	400	720	167	181
Arc	RPSC08	800	400	720	167	181
D-End 1250						
Vega	VPSC1250	1250	450	720	185	203
Arc	RPSC1250	1250	450	720	185	203
For use against two 600d tops						
D-End 1650						
Vega	VPSC1650	1650	600	720	287	314
Arc	RPSC1650	1650	600	720	287	314
For use against two 800d tops						
Teardrop extension 120°						
Vega	VPCE120	800	1200	720	297	323
Arc	RPCE120	800	1200	720	297	323
Horseshoe extension 250°						
Vega	VPCE250	1200	1050	720	312	341
Arc	RPCE250	1200	1050	720	312	341
Includes connecting brackets						
Freestanding						
D-End 1200 freestanding	MOPSC12F	1200	450	720	289	316
D-End 1600 freestanding	MOPSC16F	1600	600	720	330	359

Tip Top Tables

Typo



Description	Code	W	D	H	Price £	
					A	B
Top Options: A = Beech, Maple, Oak, White B = Cherry, Hacienda Black, Walnut, Zebrano						
Rectangular	MOTT12	1200	800	720	362	375
	MOTT14	1400	800	720	381	394
	MOTT16	1600	800	720	401	416
	MOTT18	1800	800	720	404	420
D-End	MOTTD16	1600	700	720	420	435
Trapezoidal	MOTTT16	1600	800	720	420	435

Topo



Description	Code	W	D	H	Price £	
					A	B
Top Options: A = Beech, Maple, Oak, White B = Cherry, Hacienda Black, Walnut, Zebrano						
Rectangular	MOTOPO12Ø8	1200	800	720	483	496
	MOTOPO14Ø8	1400	800	720	491	504
	MOTOPO16Ø8	1600	800	720	497	512
	MOTOPO18Ø8	1800	800	720	500	516
Circular	MOTOPOSØ8		800ø	720	421	464

Modesty Panels



Description	Code	W	D	H	Price £	
					A	B
Top Options: A = Beech, Maple, Oak, White B = Cherry, Hacienda Black, Walnut, Zebrano						
Hinged modesty panel	MOTTM12	1050	300		76	83
Not suitable for trapezoidal, D-End or circular tops	MOTTM14	1250	300		80	88
	MOTTM16	1450	300		84	93
	MOTTM18	1650	300		90	98

Folding / Mobile Tables

Rolo Folding Tables



Description	Code	W	D	H	Price £	
					A	B
Top Options: A = Beech, Maple, Oak, White B = Cherry, Hacienda Black, Walnut, Zebrano						
Rectangular	MOFT12	1200	800	720	315	328
	MOFT14	1400	800	720	335	348
	MOFT16	1600	800	720	355	371
D-End	MOFTD16	1600	600	720	375	390
Trapezoidal	MOFTT16	1600	800	720	375	390

Mobile Axis



Description	Code	W	D	H	Price £	
					A	B
Top Options: A = Beech, Maple, Oak, White B = Cherry, Hacienda Black, Walnut, Zebrano						
Axis meeting table	MOIT12M	1200	800	720	312	325
Axis meeting table	MOIT14M	1400	800	720	316	329
Axis meeting table	MOIT16M	1600	800	720	346	361
Axis meeting table	MOIT18M	1800	800	720	356	372

Connectors



Description	Code	W	D	H	Price £
Click catch connector	MOMTTC	153	58	6	15

Meeting Tables

Spin



Description	Code	W	D	H	Price £	
					A	B
Top Options: A = Beech, Maple, Oak, White B = Cherry, Hacienda Black, Walnut, Zebrano						
Spin circular coffee table	SPCT06	600ø		400	218	226
Spin circular meeting table	SPT08	800ø		720	275	285
	SPT10	1000ø		720	315	329
	SPT12	1200ø		720	465	484
Spin circular poseur table	SPPT06	600ø		1125	272	280
	SPPT08	800ø		1125	288	298
Spin square coffee table	SPCT66	600	600	400	188	194
Spin square meeting table	SPT77	700	700	720	238	244
	SPT88	800	800	720	253	261
	SPT99	900	900	720	267	276
	SPT1010	1000	1000	720	384	394
Spin square poseur table	SPPT66	600	600	1125	242	247
	SPPT77	700	700	1125	252	258
Brushed steel frame and base						

Meeting Tables

Flick



Description	Code	W	D	H	Price £	
					A	B
Top Options: A = Beech, Maple, Oak, White B = Cherry, Hacienda Black, Walnut, Zebrano						
Flick square coffee table	FKCS66	600	600	400	161	166
	FKCS77	700	700	400	171	177
Flick square meeting table	FKMS66	600	600	730	206	212
	FKMS77	700	700	730	216	222
	FKMS88	800	800	730	231	239
Flick square poseur table	FKPS66	600	600	1125	210	215
	FKPS77	700	700	1125	219	225
Flick circular coffee table	FKC06	600ø		400	191	199
	FKC07	700ø		400	191	199
Flick circular meeting table	FKM08	800ø		730	272	284
	FKM09	900ø		730	294	307
	FKM10	1000ø		730	256	266
Flick circular poseur table	FKP08	800ø		1125	243	253
Chrome frame and base						

Meeting Tables

Rio



Description	Code	W	D	H	Price £	
Top Options: A = Beech, Maple, Oak, White B = Cherry, Hacienda Black, Walnut, Zebrano					A	B
Rio square table with chamfered edges	RIC88	800	800	750	514	536
	RIC1010	1000	1000	750	572	600
Rio square table with standard square top	RIS88	800	800	750	398	409
	RIS1010	1000	1000	750	427	441
Rio square table with standard top with radiused corners	RIR88	800	800	750	424	438
	RIR1010	1000	1000	750	460	477

Beech 50mm Dia legs

Meeting Tables

Cruise



Description	Code	W	D	H	Price £	
Top Options: A = Beech, Maple, Oak, White B = Cherry, Hacienda Black, Walnut, Zebrano					A	B
Cruise rectangular meeting table	CRTR2612	2600	1200	730	1284	1310
Cruise rectangular meeting table	CRTR1608	1600	800	730	738	753
	CRTR1808	1800	800	730	749	764
	CRTR2010	2000	1000	730	779	797
	CRTR2408	2400	800	730	1008	1026
	CRTR2409	2400	900	730	1028	1047
	CRTR2410	2400	1000	730	1044	1065
Cruise circular meeting table	CRTC10	1000Ø		730	559	573

Black / chrome frame and base



Meeting Tables

Vega



Description	Code	W	D	H	Price £	
Top Options: A = Beech, Maple, Oak, White B = Cherry, Hacienda Black, Walnut, Zebrano					A	B
Frame Options Suffix Code: S = Silver W = White						
Circular						
800ø	MOMT08V	800ø		720	448	465
1000ø	MOMT10V	1000ø		720	469	487
1200ø	MOMT12V	1200ø		720	510	533
1400ø	MOMT14V	1400ø		720	552	579
1600ø	MOMT16V	1600ø		720	602	632
Rectangular						
1200 x 800	MOIT12V	1200	800	720	413	424
1400 x 800	MOIT14V	1400	800	720	423	436
1600 x 800	MOIT16V	1600	800	720	483	497
1800 x 800	MOIT18V	1800	800	720	486	502
2000 x 1000	MORC2010V	2000	1000	720	511	534
2400 x 1200	MORC2412V	2400	1200	720	572	600
Oval						
2000 x 1000	MOC2010V	2000	1000	720	624	658
2000 x 1200	MOC2012V	2000	1200	720	641	677
2400 x 1200	MOC2412V	2400	1200	720	677	716
Barrel						
2000 x 1000-1200	MOBC2012V	2000	1200	720	651	688
2400 x 1000-1300	MOBC2413V	2400	1300	720	706	748

Infinity



Description	Code	W	D	H	Price £	
Top Options: A = Beech, Maple, Oak, White B = Cherry, Hacienda Black, Walnut, Zebrano					A	B
Frame Options Suffix Code: S = Silver W = White						
Rectangular						
1200 x 800	MOIT12I	1200	800	745	520	531
1400 x 800	MOIT14I	1400	800	745	540	552
1600 x 800	MOIT16I	1600	800	745	564	579
1800 x 800	MOIT18I	1800	800	745	639	654
2000 x 1000	MORC2010I	2000	1000	745	697	720
2400 x 1200	MORC2412I	2400	1200	745	753	782
Barrel						
2000 x 1000-1200	MOBC2012I	2000	1200	745	775	812
2400 x 1000-1300	MOBC2413I	2400	1300	745	887	929

Meeting Tables

Axis



Description	Code	W	D	H	Price £	
Top Options: A = Beech, Maple, Oak, White B = Cherry, Hacienda Black, Walnut, Zebrano					A	B
Frame Options Suffix Code: S = Silver W = White						
Circular						
800ø	MOMT08A	800ø		720	304	320
1000ø	MOMT10A	1000ø		720	330	348
1200ø	MOMT12A	1200ø		720	342	365
1400ø	MOMT14A	1400ø		720	381	408
1600ø	MOMT16A	1600ø		720	431	461
Rectangular						
1200 x 800	MOIT12A	1200	800	720	288	300
1400 x 800	MOIT14A	1400	800	720	293	305
1600 x 800	MOIT16A	1600	800	720	322	337
1800 x 800	MOIT18A	1800	800	720	333	348
Oval						
2000 x 1000	MOC2010A	2000	1000	720	493	527
2000 x 1200	MOC2012A	2000	1200	720	512	548
2400 x 1200	MOC2412A	2400	1200	720	539	578

Arrow



Description	Code	W	D	H	Price £	
Top Options: A = Beech, Maple, Oak, White B = Cherry, Hacienda Black, Walnut, Zebrano					A	B
Frame Options Suffix Code: S = Silver W = White						
Circular						
1000ø	MOMT10W	1000ø		720	324	357
1200ø	MOMT12W	1200ø		720	358	394
1400ø	MOMT14W	1400ø		720	403	443
1600ø	MOMT16W	1600ø		720	458	505
Rectangular						
1200 x 800	MOIT12W	1200	800	720	504	554
1400 x 800	MOIT14W	1400	800	720	517	569
1600 x 800	MOIT16W	1600	800	720	531	585
1800 x 800	MOIT18W	1800	800	720	543	597
2000 x 1000	MORC2010W	2000	1000	720	614	676
2400 x 1200	MORC2412W	2400	1200	720	658	724
Oval						
2000 x 1000	MOC2010W	2000	1000	720	686	755
2000 x 1200	MOC2012W	2000	1200	720	710	781
2400 x 1200	MOC2412W	2400	1200	720	751	826
Barrel						
2000 x 1000-1200	MOBC2012W	2000	1200	720	717	789
2400 x 1000-1300	MOBC2413W	2400	1300	720	782	860

Vega Conference Tables

Vega Conference Tables

Description	Code	W	D	H	Price £	
Top Options: A = Beech, Maple, Oak, White B = Cherry, Hacienda Black, Walnut, Zebrano					A	B
Frame Options Suffix Code: S = Silver W = White						
Freestanding table	VRC1412F	1400	1250	720	817	859
	VRC1612F	1600	1250	720	872	921
	VRC1812F	1800	1250	720	940	995
	VRC2012F	2000	1250	720	1031	1086
	VRC2212F	2200	1250	720	1086	1147
	VRC2412F	2400	1250	720	1140	1208
	VRC1416F	1400	1650	720	992	1044
	VRC1616F	1600	1650	720	1063	1124
	VRC1816F	1800	1650	720	1147	1218
	VRC2016F	2000	1650	720	1254	1328
	VRC2216F	2200	1650	720	1325	1409
	VRC2416F	2400	1650	720	1399	1489



3200 x 1650 Vega table in walnut shown with optional rotate and reveal power units. Visita cantilever chairs.



Description	Code	W	D	H	Price £		
Top Options: A = Beech, Maple, Oak, White B = Cherry, Hacienda Black, Walnut, Zebrano					A	B	
Frame Options Suffix Code: S = Silver W = White							
Starter module	VRC1412S	1400	1250	720	830	872	
	VRC1612S	1600	1250	720	898	947	
	VRC1812S	1800	1250	720	985	1040	
	VRC2012S	2000	1250	720	1044	1098	
	VRC1416S	1400	1650	720	1002	1053	
	VRC1616S	1600	1650	720	1086	1147	
	VRC1816S	1800	1650	720	1189	1260	
	VRC2016S	2000	1650	720	1263	1338	
	Add on module	VRC1412A	1400	1250	720	678	720
		VRC1612A	1600	1250	720	766	814
		VRC1812A	1800	1250	720	821	876
		VRC2012A	2000	1250	720	879	934
End module	VRC1412E	1400	1250	720	653	695	
	VRC1612E	1600	1250	720	720	769	
	VRC1812E	1800	1250	720	808	863	
	VRC2012E	2000	1250	720	866	921	
Add on module	VRC1416A	1400	1650	720	827	879	
	VRC1616A	1600	1650	720	930	992	
	VRC1816A	1800	1650	720	1002	1073	
	VRC2016A	2000	1650	720	1076	1150	
End module	VRC1416E	1400	1650	720	804	856	
	VRC1616E	1600	1650	720	888	950	
	VRC1816E	1800	1650	720	992	1063	
	VRC2016E	2000	1650	720	1066	1140	



Cut out for cable management / power units = £100 RRP per module. Please specify type and position required when ordering. See page 98 for options

Starter Module



Add on Module



Description	Code	W	D	H	Price £	
					A	B
Top Options: A = Beech, Maple, Oak, White B = Cherry, Hacienda Black, Walnut, Zebrano						
IRC1412S		1400	1250	745	845	865
IRC1612S		1600	1250	745	900	923
IRC1812S		1800	1250	745	942	967
IRC2012S		2000	1250	745	1007	1034
IRC2412S		2400	1250	745	1112	1145
IRC1416S		1400	1650	745	892	917
IRC1616S		1600	1650	745	950	976
IRC1816S		1800	1650	745	1017	1048
IRC2016S		2000	1650	745	1084	1121
IRC2416S		2400	1650	745	1090	1130
IRC1412A		1400	1250	745	758	778
IRC1612A		1600	1250	745	814	837
IRC1812A		1800	1250	745	856	881
IRC2012A		2000	1250	745	921	948
IRC2412A		2400	1250	745	1026	1059
IRC1416A		1400	1650	745	816	841
IRC1616A		1600	1650	745	873	899
IRC1816A		1800	1650	745	940	971
IRC2016A		2000	1650	745	1007	1044
IRC2416A		2400	1650	745	1096	1136

Cut out for cable management / power units = £100 RRP per module.
Please specify type and position required when ordering. See page 98 for options.



Breakout Bars



Description	Code	W	D	H	Price £	
					A	B
38mm Panel Options: Cherry, Walnut, White. Contrasting Modesty Options Available						
Freestanding	BF1606	1600	600	1100	1032	
	BF1806	1800	600	1100	1099	
	BF2006	2000	600	1100	1148	
	BF1608	1600	800	1100	1266	
	BF1808	1800	800	1100	1332	
	BF2008	2000	800	1100	1399	
Wall mounted with panel end	BWE1606	1600	600	1100	965	
	BWE1806	1800	600	1100	1050	
	BWE2006	2000	600	1100	1115	
	BWE1608	1600	800	1100	1132	
	BWE1808	1800	800	1100	1215	
	BWE2008	2000	800	1100	1299	
Wall mounted with pedestal base	BP1606	1600	600	1138	1181	
	BP1806	1800	600	1138	1232	
	BP2006	2000	600	1138	1266	
	BP1608	1600	800	1138	1381	
	BP1808	1800	800	1138	1433	
	BP2008	2000	800	1138	1482	

Café Benches



Description	Code	W	D	H	Price £	
					A	B
38mm Panel Options: Cherry, Walnut, White. Contrasting Modesty Options Available						
Cafe bench table	CBT1608	1600	800	730	965	
	CBT1808	1800	800	730	1032	
	CBT2008	2000	800	730	1083	
	CBT1610	1600	1000	730	1165	
	CBT1810	1800	1000	730	1232	
	CBT2010	2000	1000	730	1299	
Cafe bench seat	CBS1500	1500	330	450	533	
	CBS1700	1700	330	450	582	
	CBS1900	1900	330	450	632	

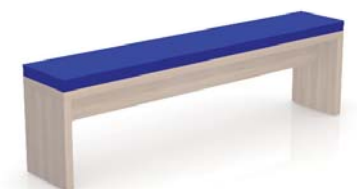

Description	Code	W	D	H	Price £			
					A	B	C	D
Cafe bench seat pad (not inc bench)	CBP1500	1500	330	50	170	194	252	290
	CBP1700	1700	330	50	185	213	277	320
	CBP1900	1900	330	50	201	232	303	350

Desking and Table Accessories

Cable Management



Monitor Arms



Description	Code	W	D	H	Price £
Cable tray	MOCT85	850	150		32
For fitting to modesty panels	MOCT10	1000	150		40
	MOCT15	1400	150		57
Cable tray set	SMTCTSL	1400-2000	150		129
Includes fit anywhere hangers	SMTCTSS	900-1400	150		111
Slinky	MOFCR			720	40
Tray to floor cable management for standard height desking					
Extendable spiral cable spine	CAB-SPI-FLX-SIL			680-1180	71
Suitable for height adjustable desking					
Cable hole tidy	CHTALUS	80	80	25	32
	CHTALUR	80	150	25	42
Desk mounted gas lift monitor arm	DMGLMO				105
(Supports monitors up to 5kg)					
Desk mounted heavy duty aluminium gas lift monitor arm	DMHDGLMO				195
(Supports monitors from 4kg up to 9kg)					
Screen mounted monitor arm	MOTRFSA				196

Above Desk Power



Through Desk Power



Under Desk Power



Description	Code	W	D	H	Price £
Desktop power module 2 x power sockets and 1 x data with 1 switch. Inc 2m leads	KD2P1D2M				119
Desktop power module 2 x power sockets and 2 x USB smart charge, 1 x data with 1 switch. Inc 2m leads Available in white or silver	KD2P1D1USB2M				282
Aero flip and reveal power module 2 x power sockets and 2 x data with 1 switch. Inc 2m leads (USB, HDMI, audio and data options available) Available in white or silver	AF2P2D	256	130		234
Low profile flip and reveal power module 2 x power sockets and 2 x data with 1 switch. Inc 2m leads (USB, HDMI, audio and data options available) Available in white or silver	KF2P2D	238	148		219
Porthole power module 1 UK socket 1 x CAT 5e data Inc 2m leads	PH1P1D2M	80	80		96
Porthole power module 1 UK socket 2 x smart charge USB Inc 2m leads	PH1P1D1USB2M	80	80		282
Under desk power module 4 x power sockets with 1 switch	M04GPS				47
Under desk power module 3 x power sockets with 1 switch	M03GPS				39
Under desk power module 2 x power sockets with 1 switch	M02GPS				32
2m power lead	M0MLP2M				17
3m power lead	M0MLP3M				19
1m connecting lead	M0MCP1M				22
2m connecting lead	M0MCP2M				24

Coffee Tables

Pitch



Description	Code	W	D	H	Price £		
					A	B	C
Top Options: A = Beech, Maple, Oak, White B = Cherry, Hacienda Black, Walnut, Zebrano C = Glass							
Pitch square Chrome frame Available in frosted glass and MFC	PT0606	600	600	420	332	338	449
Pitch rectangular Chrome frame Available in frosted glass and MFC	PT1206	1200	600	420	399	408	560

Loop



Description	Code	W	D	H	Price £		
					A	B	C
Top Options: A = Beech, Maple, Oak, White B = Cherry, Hacienda Black, Walnut, Zebrano C = Glass							
Loop square Chrome frame Available in frosted glass and MFC	LP0606	600	600	420	421	426	499
Loop rectangular Chrome frame Available in frosted glass and MFC	LP1206	1200	600	420	481	489	638

Spin



Description	Code	W	D	H	Price £	
					A	B
Top Options: A = Beech, Maple, Oak, White B = Cherry, Hacienda Black, Walnut, Zebrano						
Spin circular coffee table	SPCT06		600ø	400	207	215
Spin square coffee table Brushed steel frame and base	SPCT66	600	600	400	177	182

Cuban



Description	Code	W	D	H	Price £	
					A	B
Top Options: A = Beech, Maple, Oak, White B = Cherry, Hacienda Black, Walnut, Zebrano						
Cuban coffee table	CU10	1000	500	325	338	354

Coffee Tables

Flick



Description	Code	W	D	H	Price £	
					A	B
Top Options: A = Beech, Maple, Oak, White B = Cherry, Hacienda Black, Walnut, Zebrano						
Flick circular coffee table	FKC06		600ø	400	182	190
	FKC07		700ø	400	182	190
Flick square coffee table Chrome frame and base	FKCS66	600	600	400	152	157
	FKCS77	700	700	400	162	168

Quattro



Description	Code	W	D	H	Price £	
					A	B
Top Options: A = Beech, Maple, Oak, White B = Cherry, Hacienda Black, Walnut, Zebrano						
Quattro square coffee table	MOC066	600	600	400	229	252
Quattro rectangular coffee table	MOC010	1000	600	400	236	259
Quattro circular coffee table Silver frame	MOCOC08		800ø	400	324	357

Paris



Description	Code	W	D	H	Price £	
					A	B
Top Options: A = Beech, Maple, Oak, White B = Cherry, Hacienda Black, Walnut, Zebrano						
Paris circular coffee table	PP07		700ø	400	183	193
Paris square coffee table Chrome wire frame	PP66	600	600	400	134	139

Storage

MFC Pedestals



Description	Code	W	D	H	Price £			
					Standard		Heavy Duty	
Suffix code with H for Heavy Duty Drawer					A	B	A	B
Top Options: A = Beech, Maple, Oak, White B = Cherry, Hacienda Black, Walnut, Zebrano								
Fixed pedestals								
2 Drawer	MPWF2	430	600	465	158	174	200	219
3 Drawer	MPWF3	430	600	465	158	174	-	-
For use with 800d Contrax2 rectangular desks only								
Mobile pedestals								
2 Drawer	MPW62	430	600	540	191	209	241	264
3 Drawer	MPW63	430	600	540	191	209	-	-
Mobile 2 drawer pedestal with Seat pad								
	UPS50/A	430	600	590	-	-	394	417
	UPS50/B	430	600	590	-	-	403	426
Please refer to page 172 for fabric options.								
	UPS50/C	430	600	590	-	-	413	436
	UPS50/D	430	600	590	-	-	417	440
	UPS50/E	430	600	590	-	-	483	506
High mobile								
3 Drawer	HMPW63	430	600	605	226	248	306	332
Slimline high mobile								
	SHMPW63	325	600	605	214	236	-	-
Personal storage unit (Includes 1 shelf)								
	SPSU	310	600	605	197	216	-	-

Storage

MFC Pedestals



Description	Code	W	D	H	Price £			
					Standard		Heavy Duty	
Suffix code with H for Heavy Duty Drawer								
Top Options: A = Beech, Maple, Oak, White B = Cherry, Hacienda Black, Walnut, Zebrano								
Desk high 600d								
2 Drawer	DHW62	430	600	720	235	258	-	-
3 Drawer	DHW63	430	600	720	235	258	293	321
4 Drawer	DHW64	430	600	720	235	258	-	-
Desk high support ped without top 600d								
3 Drawer	DHSW63	430	600	695	220	243	280	308
Desk high 800d								
2 Drawer	DHW82	430	800	720	258	283	-	-
3 Drawer	DHW83	430	800	720	258	283	319	352
4 Drawer	DHW84	430	800	720	258	283	-	-
Desk high support ped without top 800d								
3 Drawer	DHSW83	430	800	695	245	270	307	338

Options



Description	Unit Type	Code	W	D	H	Price £
Aero handle matt chrome	Storage	MOPHDS	225	30		5
	Pedestals	MOPHDP	225	30		5
Flat D handle brushed metal	Storage	MOH192AS	200	30		8
	Pedestals	MOH192AP	200	30		8
Tapered handle matt chrome	Storage	MOH192BS	205	37		8
	Pedestals	MOH192BP	205	37		8
Bar handle matt chrome	Storage	MOH192CS	220	35		8
	Pedestals	MOH192CP	220	35		8
Pen tray	For standard pedestal	MOPPT	335	215	30	6
	For heavy duty pedestal	MOMPPT	335	215	30	6

Storage

Steel Pedestals



High mobile bow front
3 Drawer – silver
3 Drawer – white
Includes pen tray

BHMPW63
BHMPW63W

390
390

565
565

600
600

233
233

-
-



Slimline mobile bow front
3 Drawer – silver
3 Drawer – white
Includes pen tray

BSHMPW63
BSHMPW63W

310
310

565
565

560
560

233
233

-
-

Return Caddies



One drawer
(Left handed/right handed)
Fits A4 suspension files
305mm
Left hand shown

MOIRC1DL/R

450

815

570

496

546



Two drawer
(Non-handed)
Fits A4 suspension files
305mm

MOIRC2D

450

815

570

599

660



Three drawer
(Left handed/right handed)
Fits A4 suspension files
305mm
Left hand shown

MOIRC3DL/R

450

815

570

703

775



Seat pad to fit return caddies
Please refer to page 172 for
fabric options.

MOIRCSP/A
MOIRCSP/B
MOIRCSP/C
MOIRCSP/D
MOIRCSP/E

390
390
390
390
390

420
420
420
420
420

50
50
50
50
50

116
125
135
139
205

-
-
-
-
-

Storage

Tall Caddies



Mobile caddy
Open top box and 3 drawers
RH illustrated (600d)

MOSMC06L/R
MOSMC08L/R

410
410

600
800

1170
1170

420
492

462
541



Mobile caddy
With side opening tambour
and 3 drawers RH illustrated

MOSMCT06L/R
MOSMCT08L/R

410
410

600
800

1170
1170

575
656

632
721

Filing Cabinets



Filing cabinet
4 Drawer
Carcass in matching finish

MOS4DFC

500

600

1410

631

694

Storage



Description	Code	W	D	H	Price £		
					A	B	
Top Options: A = Beech, Maple, Oak, White B = Cherry, Hacienda Black, Walnut, Zebrano							
Bookcase carcass in matching finish	1 adjustable shelf	MOQK07	800	350	720	219	242
	2 adjustable shelves	MOQK12	800	350	1200	298	328
	3 adjustable shelves	MOQK16 *	800	350	1600	373	410
	4 adjustable shelves	MOQK20 *	800	350	2000	432	475
	1 adjustable shelf	MOQK0710	1000	350	720	242	266
	2 adjustable shelves	MOQK1210	1000	350	1200	328	361
	3 adjustable shelves	MOQK1610 *	1000	350	1600	410	450
	4 adjustable shelves	MOQK2010 *	1000	350	2000	475	522
Bookcase with doors carcass in matching finish	1 adjustable shelf	MOQR0708	800	350	720	330	363
	2 adjustable shelves	MOQR1208	800	350	1200	450	495
	3 adjustable shelves	MOQR1608 *	800	350	1600	560	616
	4 adjustable shelves	MOQR2008 *	800	350	2000	656	722
	1 adjustable shelf	MOQR07	1000	350	720	347	381
	2 adjustable shelves	MOQR12	1000	350	1200	474	521
	3 adjustable shelves	MOQR16 *	1000	350	1600	590	649
	4 adjustable shelves	MOQR20 *	1000	350	2000	691	760
Bookcase with glass doors carcass in matching finish Non locking	1 adjustable shelf	MOQL07	1000	350	720	482	529
	2 adjustable shelves	MOQL12	1000	350	1200	614	676
	3 adjustable shelves	MOQL16 *	1000	350	1600	816	897
	4 adjustable shelves	MOQL20 *	1000	350	2000	932	1026
Open fronted storage unit Silver carcass as standard	MOQF0708	800	500	720	249	274	
	MOQF07	1000	500	720	276	304	
	MOQF12	1000	500	1200	354	389	
	MOQF16	1000	500	1600	430	473	
	MOQF20	1000	500	2000	485	534	
Double door storage unit Silver carcass as standard	MOQD0708	800	500	720	343	377	
	MOQD07	1000	500	720	380	418	
	MOQD12	1000	500	1200	502	552	
	MOQD16	1000	500	1600	608	668	
	MOQD20	1000	500	2000	694	706	

* Units must be wall fixed when installed

Storage



Mobile Conversion Kit



Description	Code	W	D	H	Price £	
					A	B
Top Options: A = Beech, Maple, Oak, White B = Cherry, Hacienda Black, Walnut, Zebrano						
Combination storage unit Silver carcass as standard	MOQQ20	1000	500	2000	748	823
	Internal heights of storage compartments are 1125mm / 790mm					
Side opening tambour unit Silver carcass / tambour	MOQT0708	800	500	720	469	516
	MOQT07	1000	500	720	517	569
	MOQT12	1000	500	1200	645	710
	MOQT16	1000	500	1600	754	830
	MOQT20	1000	500	2000	842	925
Side opening tambour unit White carcass / tambour	MOQT0708WT	800	500	720	469	516
	MOQT07WT	1000	500	720	517	569
	MOQT12WT	1000	500	1200	645	710
	MOQT16WT	1000	500	1600	754	830
	MOQT20WT	1000	500	2000	842	925
Frosted glass door storage unit Silver carcass as standard	MOQG07	1000	500	720	507	558
	MOQG12	1000	500	1200	652	718
	MOQG16	1000	500	1600	801	881
	MOQG20	1000	500	2000	953	1048
Non locking						
Sidefiler Two filing drawers 800w	MOQSF08	800	500	725	781	859
	MOQSF	1000	500	725	854	939
Includes file conversion bars Silver carcass as standard						
Glass tops for storage Available in white, black or frosted	GT105	1000	500	-	-	541
	GT103	1000	350	-	-	494
	GT085	800	500	-	-	433
Set of 4 castors For use on 500d storage only up to 1200h max	MOQA4BS	-	-	-	-	68

Set of 4 castors
For use on 500d storage only
up to 1200h max

Storage Internals



Description	Code	W	D	H	Price £
Silver MFC shelves					
For 800w storage unit	MOQWS08S	745	400	25	35
For 800w tambour unit	MOQWTS08S	665	400	25	35
For 1000w storage unit	MOQWS	945	400	25	37
For 1000w tambour unit	MOQWTS	865	400	25	37
White MFC shelves					
For 800w tambour unit	MOQWTS08W	665	400	25	35
For 1000w tambour unit	MOQWTW	865	400	25	37
Matching finish available at additional cost					



Lateral filing shelf					
For 1000w storage unit	MOQLFS	945	391		55
For 1000w tambour unit	MOQLFS	865	391		55
Rails 330mm apart for A4 folders					

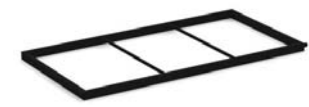

Pull out suspension filing cradle					
For 800w storage unit	MOQPSFF08	745	405		147
For 800w tambour unit	MOQPTSFF08	765	405		147
Rails 388mm apart for foolscap folders. Not suitable for A4 folders.					
For 1000w storage unit	MOQPSFF	945	405		147
For 1000w tambour unit	MOQPTSFF	865	405		147
Rails 388mm apart for foolscap folders. Includes file conversion bars to store A4 folders.					



Slotted shelf					
For 1000w storage unit	MOQSS	945	400		116
For 1000w tambour unit	MOQTSS	865	400		116

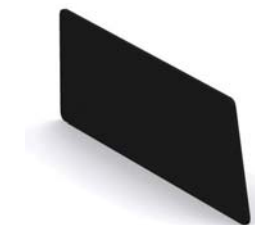

Pack of five dividers for above	MOQSSD	378	153		59
---------------------------------	--------	-----	-----	--	----



A4 conversion crossbar	MOQCCB				9
------------------------	--------	--	--	--	---











Wardrobe rail for 1000w storage units	MOWRAIL	954			52
---------------------------------------	---------	-----	--	--	----



Lockers

Lockers

Description	Code	W	D	H	Price £	
Options: A = Beech, Maple, Oak, White B = Cherry, Hacienda Black, Walnut, Zebrano					A	B
Carcass Options Suffix Code: WH = White, Z = Matching Carcass						
See page 168 for specification guide						
 2 Door locker with rim locks	MOQZR0752L/R	505	500	720	349	384
2 Door locker with pull handle with integrated lock	MOQZH0752L/R	505	500	720	407	448
2 Door locker with combination locks	MOQZC0752L/R	505	500	720	400	440
2 Door locker with electronic locks RH hinged door illustrated	MOQZE0752L/R	505	500	720	994	1093
 3 Door locker with rim locks	MOQZR1253L/R	505	500	1200	479	527
3 Door locker with pull handle with integrated lock	MOQZH1253L/R	505	500	1200	565	622
3 Door locker with combination locks	MOQZC1253L/R	505	500	1200	548	603
3 Door locker with electronic locks RH hinged door illustrated	MOQZE1253L/R	505	500	1200	1446	1591
 4 Door locker with rim locks	MOQZR1654L/R	505	500	1600	583	641
4 Door locker with pull handle with integrated lock	MOQZH1654L/R	505	500	1600	698	768
4 Door locker with combination locks	MOQZC1654L/R	505	500	1600	685	754
4 Door locker with electronic locks RH hinged door illustrated	MOQZE1654L/R	505	500	1600	1872	2059
 2 Door locker with rim locks	MOQZR1652L/R	505	500	1600	529	582
2 Door locker with pull handle with integrated lock	MOQZH1652L/R	505	500	1600	587	646
2 Door locker with combination locks	MOQZC1652L/R	505	500	1600	577	635
2 Door locker with electronic locks RH hinged door illustrated	MOQZE1652L/R	505	500	1600	1174	1291

Description	Code	W	D	H	Price £	
Options: A = Beech, Maple, Oak, White B = Cherry, Hacienda Black, Walnut, Zebrano					A	B
Carcass Options Suffix Code: WH = White, Z = Matching Carcass						
See page 168 for specification guide						
 4 Door locker with rim locks	MOQZR0714L/R	1000	500	720	615	677
4 Door locker with pull handle with integrated lock	MOQZH0714L/R	1000	500	720	730	803
4 Door locker with combination locks	MOQZC0714L/R	1000	500	720	710	781
4 Door locker with electronic locks RH hinged door illustrated	MOQZE0714L/R	1000	500	720	1904	2094
 6 Door locker with rim locks	MOQZR1216L/R	1000	500	1200	818	900
6 Door locker with pull handle with integrated lock	MOQZH1216L/R	1000	500	1200	990	1089
6 Door locker with combination locks	MOQZC1216L/R	1000	500	1200	970	1067
6 Door locker with electronic locks RH hinged door illustrated	MOQZE1216L/R	1000	500	1200	2752	3027
 8 Door locker with rim locks	MOQZR1618L/R	1000	500	1600	1030	1133
8 Door locker with pull handle with integrated lock	MOQZH1618L/R	1000	500	1600	1260	1386
8 Door locker with combination locks	MOQZC1618L/R	1000	500	1600	1230	1353
8 Door locker with electronic locks RH hinged door illustrated	MOQZE1618L/R	1000	500	1600	3609	3970
 4 Door locker with rim locks	MOQZR1614L/R	1000	500	1600	906	997
4 Door locker with pull handle with integrated lock	MOQZH1614L/R	1000	500	1600	1021	1123
4 Door locker with combination locks	MOQZC1614L/R	1000	500	1600	1179	1297
4 Door locker with electronic locks RH hinged door illustrated	MOQZE1614L/R	1000	500	1600	2196	2416

StorageWall

1000mm Wide Units

Cupboard Unit

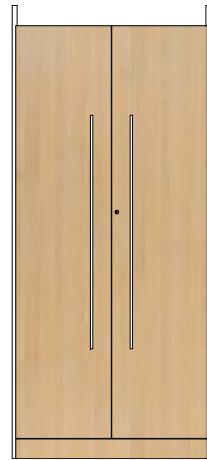

Description	Code	W	D	H	Price £
Options: Beech, Cherry, Hacienda Black, Maple, Oak, Walnut, White, Zebrano Carcass: White (See page 170 for specification guide)					
Double door cupboard unit with 1 fixed and 4 adjustable shelves					
Starter unit	MOSWSC1022	1000	500	2200	1282
Add on unit	MOSWSC1025	1000	500	2500	1410
Starter unit without shelves	MOSWSX1022	1000	500	2200	1147
Add on unit without shelves	MOSWSX1025	1000	500	2500	1263
Double door cupboard unit with 1 fixed shelf					
Starter unit	MOSWAC1022	1000	500	2200	1148
Add on unit	MOSWAC1025	1000	500	2500	1264
Double door cupboard unit with 1 fixed shelf					
Starter unit without shelves	MOSWSX1022	1000	500	2200	1147
Add on unit without shelves	MOSWSX1025	1000	500	2500	1263
Double door cupboard unit with 1 fixed shelf					
Starter unit	MOSWAX1022	1000	500	2200	1015
Add on unit	MOSWAX1025	1000	500	2500	1115

Locker Unit

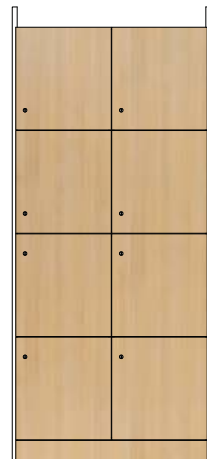

8 Door locker unit with 8 adjustable shelves and optional post slots					
Starter unit	MOSWSL1022	1000	500	2200	1653
Add on unit	MOSWSL1025	1000	500	2500	1818
Starter unit with post slots	MOSWAL1022	1000	500	2200	1519
Add on unit with post slots	MOSWAL1025	1000	500	2500	1671
Starter unit with post slots	MOSWSL10P22	1000	500	2200	1674
Add on unit with post slots	MOSWSL10P25	1000	500	2500	1839
Starter unit with post slots	MOSWAL10P22	1000	500	2200	1536
Add on unit with post slots	MOSWAL10P25	1000	500	2500	1690

Locker Unit

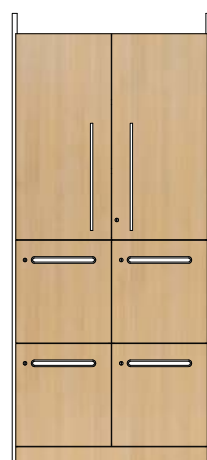

4 Door locker unit with 4 adjustable shelves and optional post slots					
Storage unit with 2 adjustable shelves					
Starter unit	MOSWSH1022	1000	500	2200	1499
Add on unit	MOSWSH1025	1000	500	2500	1650
Starter unit with post slots	MOSWAH1022	1000	500	2200	1366
Add on unit with post slots	MOSWAH1025	1000	500	2500	1502
Starter unit with post slots	MOSWSH10P22	1000	500	2200	1508
Add on unit with post slots	MOSWSH10P25	1000	500	2500	1658
Starter unit with post slots	MOSWAH10P22	1000	500	2200	1374
Add on unit with post slots	MOSWAH10P25	1000	500	2500	1511

StorageWall

1000mm Wide Units

Wardrobe Unit

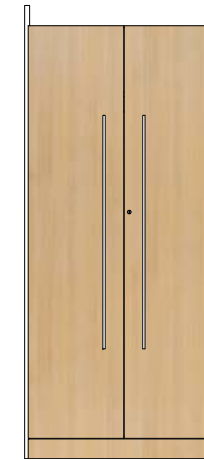

Description	Code	W	D	H	Price £
Options: Beech, Cherry, Hacienda Black, Maple, Oak, Walnut, White, Zebrano Carcass: White (See page 170 for specification guide)					
Double door wardrobe unit with 1 fixed shelf and coat rail					
Starter unit	MOSWSW1022	1000	500	2200	1110
Add on unit	MOSWSW1025	1000	500	2500	1223
Double door wardrobe unit with 1 fixed shelf and coat rail					
Starter unit	MOSWAW1022	1000	500	2200	977
Add on unit	MOSWAW1025	1000	500	2500	1074

Recycling Unit

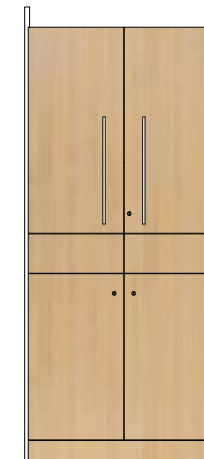

Recycling unit with 2 recycling compartments complete with drop down flaps and 2 adjustable shelves. Storage unit with 2 adjustable shelves					
Starter unit	MOSWSR1022	1000	500	2200	1396
Add on unit	MOSWSR1025	1000	500	2500	1535
Storage unit with 2 adjustable shelves					
Starter unit	MOSWAR1022	1000	500	2200	1263
Add on unit	MOSWAR1025	1000	500	2500	1388

File Drawer Unit



File drawer unit with 3 pull out file drawers to take foolscap files. Storage unit with 2 adjustable shelves					
Starter unit	MOSWSF1022	1000	500	2200	1757
Add on unit	MOSWSF1025	1000	500	2500	1932
Storage unit with 2 adjustable shelves					
Starter unit	MOSWAF1022	1000	500	2200	1623
Add on unit	MOSWAF1025	1000	500	2500	1785

StorageWall

500mm Wide Units

Cupboard Unit



Description	Code	W	D	H	Price £
Options: Beech, Cherry, Hacienda Black, Maple, Oak, Walnut, White, Zebrano Carcass: White (See page 170 for specification guide)					
Single door cupboard unit with 1 fixed and 4 adjustable shelves					
Starter unit (left / right hand)	MOSWSC522L/R	500	500	2200	949
	MOSWSC525L/R	500	500	2500	1042
Add on unit	MOSWAC522L/R	500	500	2200	815
	MOSWAC525L/R	500	500	2500	895

Locker Unit

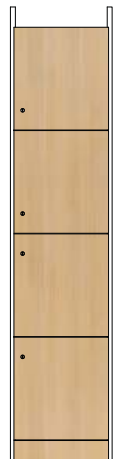

4 Door locker unit with 4 adjustable shelves and optional post slots					
Starter unit (left / right hand)	MOSWSL522L/R	500	500	2200	992
	MOSWSL525L/R	500	500	2500	1091
Add on unit	MOSWAL522L/R	500	500	2200	858
	MOSWAL525L/R	500	500	2500	943
Starter unit with post slots	MOSWSL522L/RP	500	500	2200	999
	MOSWSL525L/RP	500	500	2500	1099
Add on unit with post slots	MOSWAL522L/RP	500	500	2200	865
	MOSWAL525L/RP	500	500	2500	952

Locker Unit



4 Door locker unit with 4 adjustable shelves and optional post slots Storage unit with 2 adjustable shelves					
Starter unit (left / right hand)	MOSWSH522L/R	500	500	2200	974
	MOSWSH525L/R	500	500	2500	1070
Add on unit	MOSWAH522L/R	500	500	2200	840
	MOSWAH525L/R	500	500	2500	924
Starter unit with post slots	MOSWSH522L/RP	500	500	2200	977
	MOSWSH525L/RP	500	500	2500	1074
Add on unit with post slots	MOSWAH522L/RP	500	500	2200	844
	MOSWAH525L/RP	500	500	2500	927

StorageWall

500mm Wide Units

Wardrobe Unit



Description	Code	W	D	H	Price £
Options: Beech, Cherry, Hacienda Black, Maple, Oak, Walnut, White, Zebrano Carcass: White (See page 170 for specification guide)					
Single door wardrobe unit with 1 fixed shelf and coat rail					
Starter unit	MOSWSW522L/R	500	500	2200	925
	MOSWSW525L/R	500	500	2500	1018
Add on unit	MOSWAW522L/R	500	500	2200	791
	MOSWAW525L/R	500	500	2500	870

Recycling Unit



Recycling unit with 1 recycling compartment complete with drop down flap and adjustable shelf. Storage unit with 2 adjustable shelves					
Starter unit	MOSWSR522L/R	500	500	2200	943
	MOSWSR525L/R	500	500	2500	1037
Add on unit	MOSWAR522L/R	500	500	2200	810
	MOSWAR525L/R	500	500	2500	891

File Drawer Unit



File drawer unit with 3 pull out file drawers to take foolscap files. Storage unit with 2 adjustable shelves					
Starter unit	MOSWSF522L/R	500	500	2200	1334
	MOSWSF525L/R	500	500	2500	1467
Add on unit	MOSWAF522L/R	500	500	2200	1200
	MOSWAF525L/R	500	500	2500	1319

StorageWall

Panels

Side Panel Extensions
to increase overall unit height on open ended StorageWalls

1000mm Fascia Panels
for 1000mm wide units

500mm Fascia Panels
for 500mm wide units

Infill Panels
Available in two widths, each with six height options as standard. Other sizes available upon request.

End Fascia Panels
Other sizes available upon request.

Description	Code	W	D	H	Price £
Options: Beech, Cherry, Hacienda Black, Maple, Oak, Walnut, White, Zebrano Carcass: White (See page 170 for specification guide)					
100mm extension	MOSWSPE100	500	25	100	72
200mm extension	MOSWSPE200	500	25	200	78
300mm extension	MOSWSPE300	500	25	300	83
400mm extension	MOSWSPE400	500	25	400	90
500mm extension	MOSWSPE500	500	25	500	95
For 2200 / 2500mm total height no side panel extensions are required					
0mm extension	MOSW1FP000	1000	18	100	76
100mm extension	MOSW1FP100	1000	18	200	78
200mm extension	MOSW1FP200	1000	18	300	84
300mm extension	MOSW1FP300	1000	18	400	92
400mm extension	MOSW1FP400	1000	18	500	99
500mm extension	MOSW1FP500	1000	18	600	106
600mm extension	MOSW1FP600	1000	18	700	112
0mm extension	MOSW5FP000	500	18	100	68
100mm extension	MOSW5FP100	500	18	200	70
200mm extension	MOSW5FP200	500	18	300	74
300mm extension	MOSW5FP300	500	18	400	78
400mm extension	MOSW5FP400	500	18	500	82
500mm extension	MOSW5FP500	500	18	600	85
600mm extension	MOSW5FP600	500	18	700	91
2200 x 150mm	MOSWIP2215	150	18	2200	103
2300 x 150mm	MOSWIP2315	150	18	2300	105
2400 x 150mm	MOSWIP2415	150	18	2400	107
2500 x 150mm	MOSWIP2515	150	18	2500	109
2600 x 150mm	MOSWIP2615	150	18	2600	110
2700 x 150mm	MOSWIP2715	150	18	2700	112
2800 x 150mm	MOSWIP2815	150	18	2800	113
2200 x 550mm	MOSWIP2205	550	18	2200	156
2300 x 550mm	MOSWIP2305	550	18	2300	158
2400 x 550mm	MOSWIP2405	550	18	2400	163
2500 x 550mm	MOSWIP2505	550	18	2500	166
2600 x 550mm	MOSWIP2605	550	18	2600	171
2700 x 550mm	MOSWIP2705	550	18	2700	175
2800 x 550mm	MOSWIP2805	550	18	2800	178

StorageWall

Internals

Internals
Not included unless specified

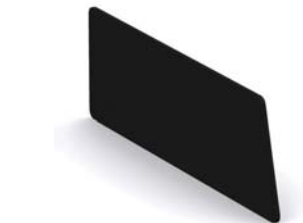

Description	Code	W	D	H	Price £
Carcass: White (See page 170 for specification guide)					
Wooden shelf Shelves are white as standard	MOSWWS	957	400	25	37
Lateral filing shelf Rails 330mm apart for A4 folders	MOSWLFS	957	391		55
Pull out suspension filing Cradle Rails 388mm apart for foolscap folders. Includes file conversion bars to store A4 folders.	MOSWPSFF	957	405		147
Slotted shelf	MOSWSS	957	400		116
Pack of five dividers for above	MOQSSD	378	153		59
A4 conversion bar	MOQCCB				9

Reception Counters

Reception Counters



Description	Code	W	D	H	Price £
Options: Beech, Cherry, Hacienda Black, Maple, Oak, Walnut, White, Zebrano (See page 169 for specification guide)					
Straight low counter	MOREC08LS	800	800	720	471
	MOREC10LS	1000	800	720	535
	MOREC12LS	1200	800	720	597
	MOREC14LS	1400	800	720	661
	MOREC16LS	1600	800	720	744
	MOREC18LS	1800	800	720	806



Straight high counter	MOREC08HS	800	800	1100	688
	MOREC10HS	1000	800	1100	784
	MOREC12HS	1200	800	1100	880
	MOREC14HS	1400	800	1100	976
	MOREC16HS	1600	800	1100	1105
	MOREC18HS	1800	800	1100	1201



90° Compact low counter	MOREC90LS	1000	1000	720	771
-------------------------	-----------	------	------	-----	-----



90° Compact high counter	MOREC90HS	1000	1000	1100	1133
--------------------------	-----------	------	------	------	------



90° Low outer curved counter	MOREC91LO	1400	1400	720	1062
------------------------------	-----------	------	------	-----	------



Description	Code	W	D	H	Price £
Options: Beech, Cherry, Hacienda Black, Maple, Oak, Walnut, White, Zebrano (See page 169 for specification guide)					
90° High outer curved counter	MOREC91HO	1400	1400	1100	1551



90° Low inner curved counter	MOREC91LI	1400	1400	720	763
------------------------------	-----------	------	------	-----	-----



90° High inner curved counter	MOREC91HI	1400	1400	1100	1052
-------------------------------	-----------	------	------	------	------



60° Low outer curved counter	MOREC60LO	2000	2000	720	1029
------------------------------	-----------	------	------	-----	------







60° High outer curved counter	MOREC60HO	2000	2000	1100	1494
-------------------------------	-----------	------	------	------	------

Reception Counters

Reception Counters

Description	Code	W	D	H	Price £
Options: Beech, Cherry, Hacienda Black, Maple, Oak, Walnut, White, Zebrano (See page 169 for specification guide)					
60° Low inner curved counter	MOREC6ØLI	2000	2000	720	835
60° High inner curved counter	MOREC6ØHI	2000	2000	1100	1154
Straight DDA accessible counter	MOREC12DD	1200	800	720	597
	MOREC14DD	1400	800	720	661
60° DDA inner accessible curved counter	MOREC6ØDD	2000	2000	720	977





Plan	Components	W	D	H	Price £
Options: Beech, Cherry, Hacienda Black, Maple, Oak, Walnut, White, Zebrano (See page 169 for specification guide)					
	MORECRLP	450	25	720	197
Recessed leg pack Includes 2 legs to create additional leg room between 2 modules. Not suitable for DDA modules.					
Typical Configurations					
	1 x MOREC16HS 1 x MOREC12DD	2800	800	720/1100	1702
	1 x MOREC16LS 2 x MOREC91HO	4270	1435	720/1100	3846
	1 x MOREC6ØDD 1 x MOREC6ØLO 3 x MOREC6ØHO	4120	3850	720/1100	6488
	1 x MOREC14DD 1 x MOREC9ØLS 1 x MOREC9ØHS 2 x MOREC16HS	3470	2635	720/1100	4775



Seating



Nero Mesh

Nero Upholstered

Description	Code	Mechanism	Arms	Price £			
				A	B	C	D
 Nero mesh back Black nylon base	TE33135	Syncro Mech	3D Height Adjustable	319	329	353	369
 Nero mesh back Seat slide Polished aluminium base and trim Black frame	TE33335	Side Adjust Syncro Mech	3D Height Adjustable	397	407	431	447
 Nero mesh back Seat slide Polished trim White powder coated aluminium base White frame	TE33335W	Side Adjust Syncro Mech	3D Height Adjustable	440	450	474	490

Description	Code	Mechanism	Arms	Price £			
				A	B	C	D
 Nero fully upholstered Black nylon base	TE33130	Syncro Mech	3D Height Adjustable	352	371	416	445
 Nero fully upholstered Seat slide Polished aluminium base and trim Black frame	TE33330	Side Adjust Syncro Mech	3D Height Adjustable	429	448	493	523
 Nero fully upholstered Seat slide Polished trim White powder coated aluminium base White frame	TE33330W	Side Adjust Syncro Mech	3D Height Adjustable	472	491	536	565

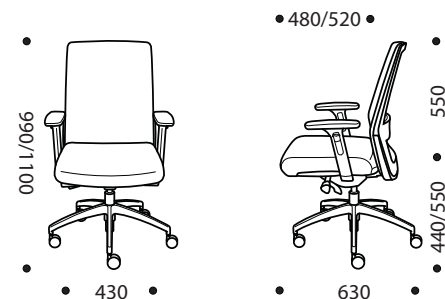

Verdi

Zel

Description	Code	Mechanism	Arms	Price £			
				A	B	C	D
Verdi fully upholstered Lumbar support, seat slide, nylon base	TV33100	Side Adjust Syncro Mech	No Arms	435	453	493	520
Verdi fully upholstered Lumbar support, seat slide, nylon base	TV33120	Side Adjust Syncro Mech	2D Height Adjustable	467	485	525	552
Verdi mesh back Lumbar support, seat slide nylon base	TV33105	Side Adjust Syncro Mech	No Arms	367	377	398	412
Verdi mesh back Lumbar support, seat slide nylon base	TV33125	Side Adjust Syncro Mech	2D Height Adjustable	399	408	429	443

Description	Code	Mechanism	Arms	Price £			
				A	B	C	D
Zel mesh back Lumbar support, seat slide, nylon base	TQ33105	Side Adjust Syncro Mech	No arms	313	322	342	356
Zel mesh back Lumbar support, seat slide, nylon base	TQ33125	Side Adjust Syncro Mech	2D Height Adjustable	345	354	374	388



Options:

Suffix with	Description	Price
M	Multi-Function Chrome Adjustable Arms – Add to unarmed price	80
S	Seat Slide - ISB and PCB mechanisms only	26
T	Polished Aluminium Spider Base	75

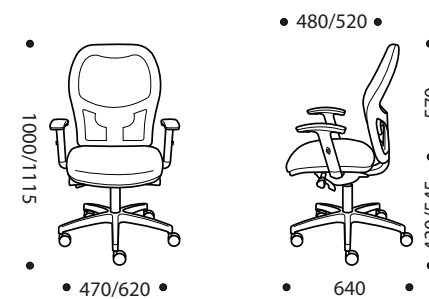
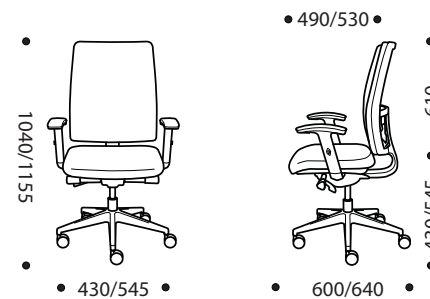

Options:

Suffix with	Description	Price
M	Multi-Function Chrome Adjustable Arms – Add to unarmed price	80
S	Seat Slide - ISB and PCB mechanisms only	26
T	Polished Aluminium Spider Base	75

Touch

Spirit



Description	Code	Mechanism	Arms	Price £			
				A	B	C	D
High back task chair Ratchet back, height adjustable	SD31400	PCB	No arms	263	273	295	310
High back task chair Ratchet back, height adjustable	SD32400	ISB	No arms	283	293	315	330
High back task chair Ratchet back, height adjustable	HD33400	24/7 HD Synchro	No arms	292	304	332	350
High back task chair Ratchet back, height adjustable	SD31420	PCB	Height adjustable	294	303	326	341
High back task chair Ratchet back, height adjustable	SD32420	ISB	Height adjustable	314	324	346	361
High back task chair Ratchet back, height adjustable	HD33420	24/7 HD Synchro	Height adjustable	323	335	363	381
Visitors / Meeting Chair Chrome frame	SD20698	Cantilever	No arms	239	246	263	274
Visitors / Meeting Armchair Chrome frame	SD20597	Cantilever	Height adjustable	270	277	294	305



Description	Code	Mechanism	Arms	Price £			
				A	B	C	D
Mesh back operators chair	ME31105	PCB	No arms	256	264	284	296
Mesh back operators chair	ME32105	ISB	No arms	291	299	319	331
Mesh back operators chair Heavy duty	ME36105	Tension ISB	No arms	301	309	328	341
Mesh back operators chair	ME31125	PCB	Height adjustable	293	302	321	333
Mesh back operators chair	ME32125	ISB	Height adjustable	328	337	356	368
Mesh back operators chair Heavy duty	ME36125	Tension ISB	Height adjustable	338	346	365	378







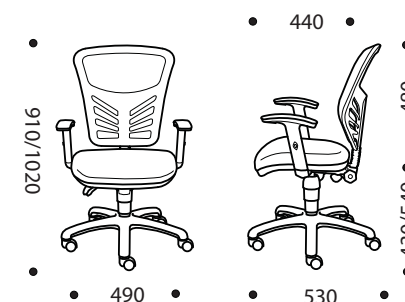
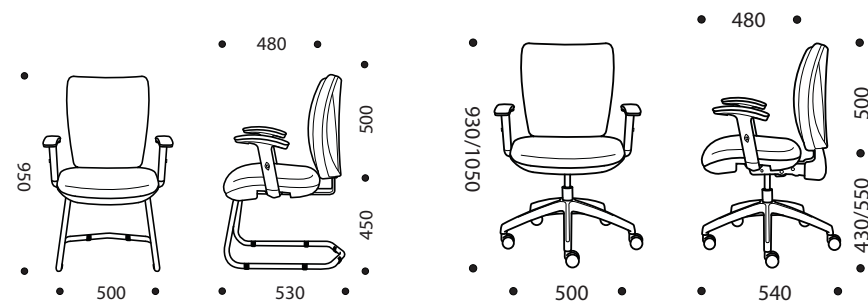









Options:

Suffix with	Description	Price
P	Pump Up Lumbar	31
M	Multi-Function Chrome Adjustable Arms – add to unarmed price	80
S	Seat Slide	26
T	Polished Aluminium Spider Base	45



Options:

Suffix with	Description	Price
M	Multi-Function Chrome Adjustable Arms – add to unarmed price	80
S	Seat Slide	26
T	Polished Aluminium Spider Base	45

Description	Code	Mechanism	Arms	Price £			
				A	B	C	D
 Medium back operators chair	ME21100	PCB	No arms	187	194	210	222
 Medium back operators chair	ME22100	ISB	No arms	200	207	224	235
 Medium back operators chair	ME21110	PCB	Fixed	201	208	225	236
 Medium back operators chair	ME22110	ISB	Fixed	214	221	238	249
 Medium back operators chair	ME21120	PCB	Height adjustable	219	226	243	254
 Medium back operators chair	ME22120	ISB	Height adjustable	232	239	256	267
 High back operators chair	ME31100	PCB	No arms	194	202	222	234
 High back operators chair	ME32100	ISB	No arms	207	215	235	248
 High back operators chair	ME36100	Tension ISB	No arms	233	241	261	274
 High back operators chair	ME31110	PCB	Fixed	208	216	236	249
 High back operators chair	ME32110	ISB	Fixed	221	230	249	262
 High back operators chair	ME36110	Tension ISB	Fixed	247	256	275	288
 High back operators chair	ME31120	PCB	Height adjustable	226	235	254	267
 High back operators chair	ME32120	ISB	Height adjustable	239	248	267	280
 High back operators chair	ME36120	Tension ISB	Height adjustable	265	274	293	306

Description	Code	Mechanism	Arms	Price £			
				A	B	C	D
 Extra high back operators chair Heavy duty Ratchet back, height adjustable	ME56100	Tension ISB	No arms	241	251	273	288
 Extra high back operators chair Heavy duty Ratchet back, height adjustable	ME56110	Tension ISB	Fixed	256	265	288	302
 Extra high back operators chair Heavy duty Ratchet back, height adjustable	ME56120	Tension ISB	Height adjustable	274	284	306	321
 Medium back visitors chair Chrome frame	ME20600	Cantilever	No arms	210	217	233	245
 Medium back visitors chair Chrome frame	ME20610	Cantilever	Fixed	224	231	248	259

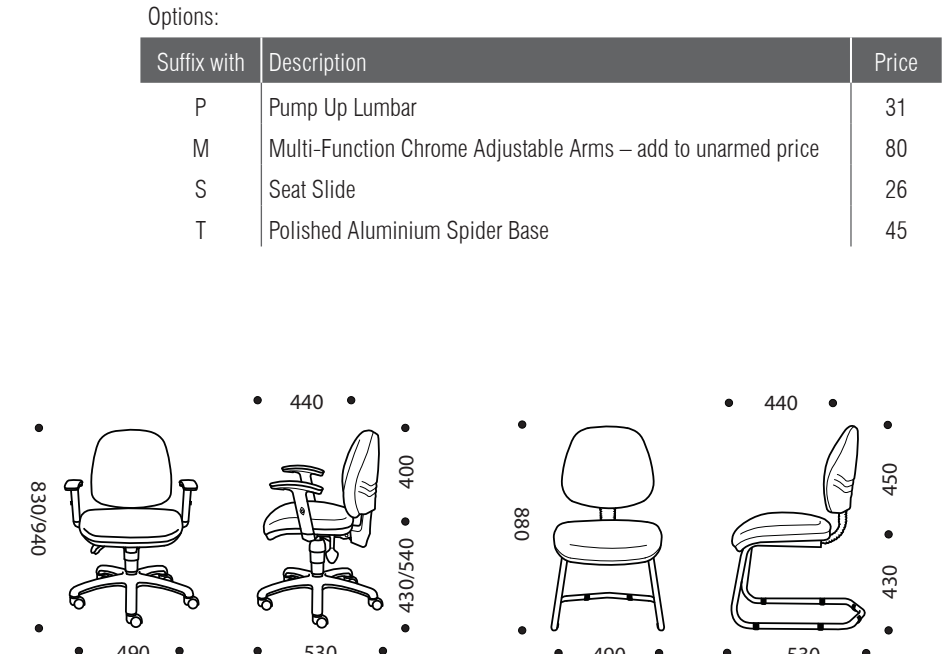
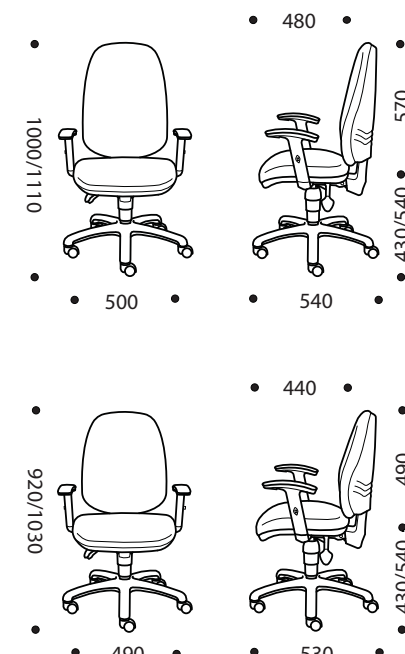

Options:

Suffix with	Description	Price
P	Pump Up Lumbar	31
M	Multi-Function Chrome Adjustable Arms – add to unarmed price	80
S	Seat Slide	26
T	Polished Aluminium Spider Base	45

Aquila

Libra



High back executive swivel armchair
Ribbed black leather

Code MA34312B

Mechanism Tilt

Arms Integrated

Price £ 502



High back executive swivel armchair
Ribbed white leather

Code MA34312W

Mechanism Tilt

Arms Integrated

Price £ 502



Low back conference swivel armchair
Ribbed black leather

Code MA1Ø312B

Mechanism Auto return

Arms Integrated

Price £ 480



Low back conference swivel armchair
Ribbed white leather

Code MA1Ø312W

Mechanism Auto return

Arms Integrated

Price £ 480

Available in black or white leather only



High back executive swivel armchair ribbed

Code ML34312

Mechanism Tilt

Arms Fixed

Price £ 475



High back executive swivel armchair soft pad

Code ML34316

Mechanism Tilt

Arms Fixed

Price £ 544



Low back conference swivel armchair ribbed

Code ML1Ø312

Mechanism Auto return

Arms Fixed

Price £ 433



Low back conference swivel armchair soft pad

Code ML1Ø316

Mechanism Auto return

Arms Fixed

Price £ 517

Available in black leather only



Memphis

Otto



Memphis extra high back executive chair
Black leather

TZ53310B

Syncro
Mech

Fixed

594



Memphis low back conference chair with arms
Black leather

TZ10300

Gas Lift
Swivel

Fixed

504



Memphis low back conference chair no arms
Black leather

TZ10310

Gas Lift
Swivel

No arms

434



Otto high back executive chair
Black leather

TT33310

Syncro
Mech

Fixed

520



Otto mid back visitor chair
Black leather

TT20690

Cantilever

Integrated

369

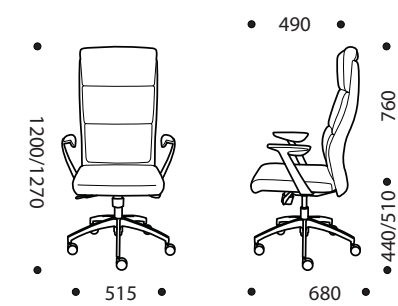
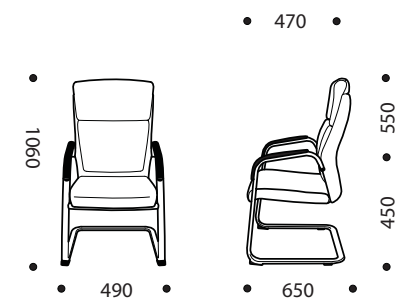
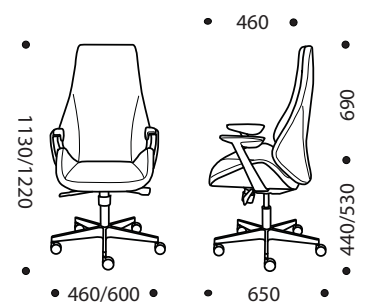
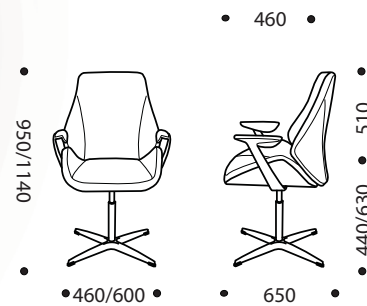

Encore

Otto

Description	Code	Mechanism	Arms	Price £
Encore high back executive chair Black leather	TN3439Ø	Tilt	Integrated	822
Encore mid back visitor chair Black leather	TN2439Ø	Gas Lift Swivel	Integrated	650



Description	Code	Mechanism	Arms	Price £
For matching executive chairs please see page 135				
Otto mid back visitor chair Black leather	TT2Ø69Ø	Cantilever	Integrated	369

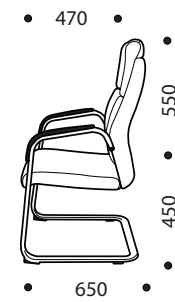
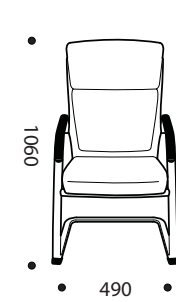
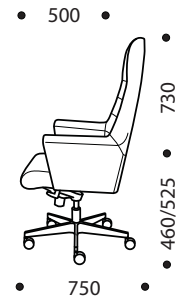
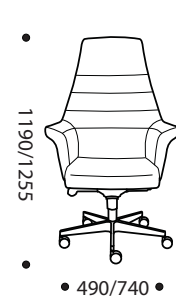
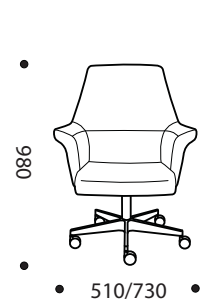

Sienna



Description	Code	Frame	Arms	Price £			
				A	B	C	D
Sienna cantilever mesh back visitors armchair	TS10295	Canilever	Integrated	240	251	277	294
Sienna mesh back visitors armchair	TS10595	4 Leg	Integrated	240	251	277	294



Visita



Description	Code	Frame	Price £				
			A	B	C	D	F
Visitors / meeting armchair Fully upholstered Chrome frame	MC10690	Cantilever	284	326	373	405	321

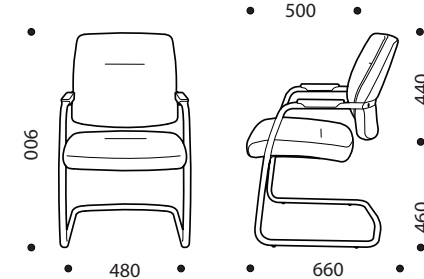
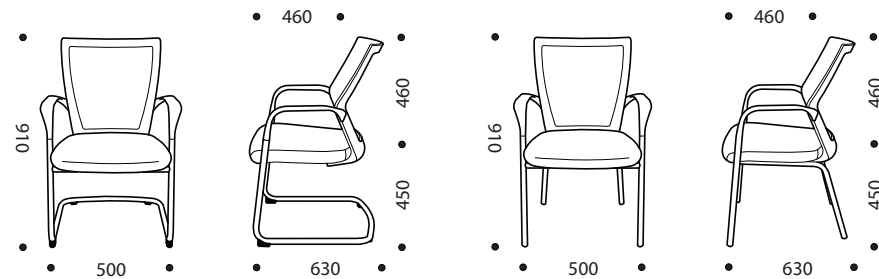

Aquila



Description	Code	Mechanism	Arms	Price £
For matching executive chairs please see page 132				
Low back conference swivel armchair Ribbed black leather	MA1Ø312B	Auto return	Integrated	480
Low back conference swivel armchair Ribbed white leather	MA1Ø312W	Auto return	Integrated	480
Available in black or white leather				



Libra



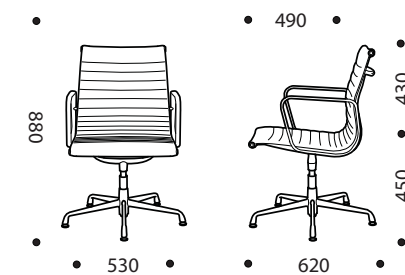
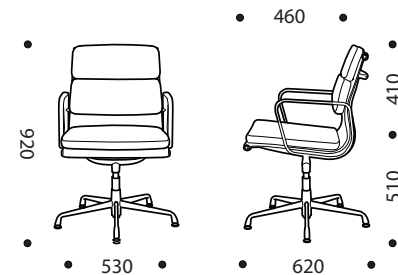
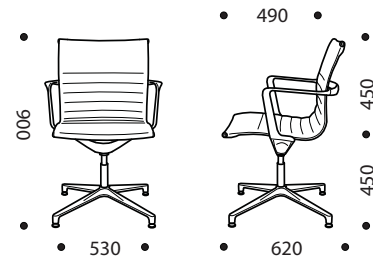

Description	Code	Mechanism	Arms	Price £
For matching executive chairs please see page 133				
Low back conference swivel armchair ribbed	ML1Ø312	Auto return	Fixed	433
Low back conference swivel armchair soft pad	ML1Ø316	Auto return	Fixed	517
Available in black leather only				



Memphis

Encore



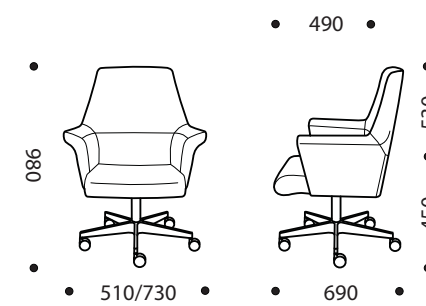
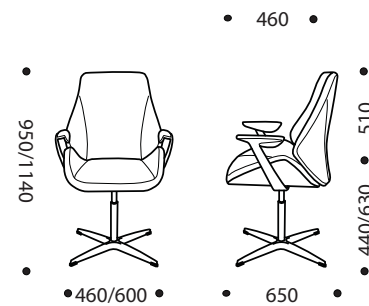

Description	Code	Mechanism	Arms	Price £
For matching executive chairs please see page 134				
 <p>Memphis low back conference chair with arms Black leather</p>	TZ10300	Gas Lift Swivel	Fixed	504
 <p>Memphis low back conference chair no arms Black leather</p>	TZ10310	Gas Lift Swivel	No arms	434

Description	Code	Mechanism	Arms	Price £
For matching executive chairs please see page 136				
 <p>Encore mid back visitor chair Black leather</p>	TN24390	Gas Lift Swivel	Integrated	650



Felix

Class

Description	Code	Frame	Arms	Price £			
				A	B	C	D
 Felix mesh back cantilever chair	TU00615	Cantilever	Integrated	234	242	262	275
 Felix upholstered cantilever chair	TU00616	Cantilever	Integrated	231	239	259	271
 Felix mesh back 4-leg chair	TU00515	4 Leg	Integrated	234	242	262	275
 Felix upholstered 4-leg chair	TU00516	4 Leg	Integrated	231	239	259	271

Description	Code	Colour	Frame	Arms	Price £			
					A	B	C	D
 Side chair, chrome legs	CL10501/BK	BLACK	4 Leg	No arms	193	-	-	-
Side chair, chrome legs	CL10501/BL	BLUE	4 Leg	No arms	193	-	-	-
Side chair, chrome legs	CL10501/WH	WHITE	4 Leg	No arms	193	-	-	-
Side chair, chrome legs	CL10501/RD	RED	4 Leg	No arms	193	-	-	-
 Side chair, chrome legs	CL10511/BK	BLACK	4 Leg	Fixed	229	-	-	-
Side chair, chrome legs	CL10511/BL	BLUE	4 Leg	Fixed	229	-	-	-
Side chair, chrome legs	CL10511/WH	WHITE	4 Leg	Fixed	229	-	-	-
Side chair, chrome legs	CL10511/RD	RED	4 Leg	Fixed	229	-	-	-
 Side chair Upholstered seat and back pad	CL10506/BK	BLACK	4 Leg	No arms	254	265	290	307
Side chair Upholstered seat and back pad	CL10506/BL	BLUE	4 Leg	No arms	254	265	290	307
Side chair Upholstered seat and back pad	CL10506/WH	WHITE	4 Leg	No arms	254	265	290	307
Side chair Upholstered seat and back pad	CL10506/RD	RED	4 Leg	No arms	254	265	290	307
 Side chair Upholstered seat and back pad	CL10516/BK	BLACK	4 Leg	Fixed	296	307	332	349
Side chair Upholstered seat and back pad	CL10516/BL	BLUE	4 Leg	Fixed	296	307	332	349
Side chair Upholstered seat and back pad	CL10516/WH	WHITE	4 Leg	Fixed	296	307	332	349
Side chair Upholstered seat and back pad	CL10516/RD	RED	4 Leg	Fixed	296	307	332	349

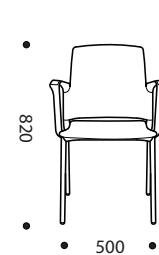
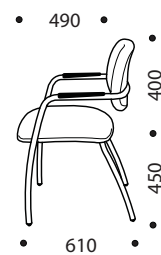
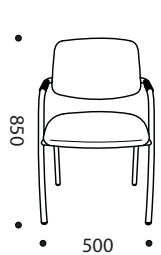
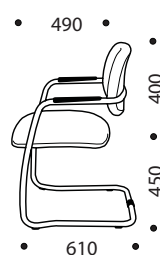
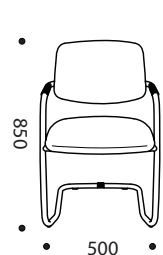

Edith



Description	Code	Frame	Arms	Price £					
					M	A	B	C	D
Edith café chair black shell	TL10501/BK	Beech	No Arms	188					
Edith café chair white shell	TL10501/WH	Beech	No Arms	188					
Edith café chair grey shell	TL10501/GY	Beech	No Arms	188					

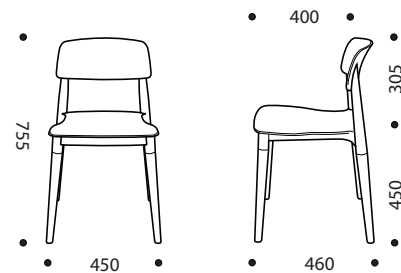

Eva



Description	Code	Frame	Arms	Price £				
				M	A	B	C	D
Eva wooden dining chair with fabric seat pad	TJ10503	Wood	No Arms	268	295	302	317	328

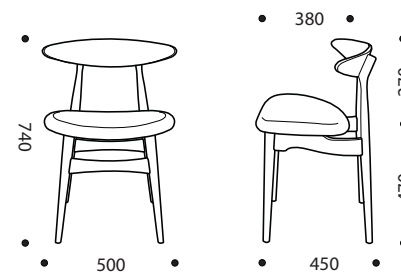

Harriet Upholstered



Description	Code	Frame	Price £
Upholstered in blazer fabric			
Harriet Upholstered Visitor / Meeting Chair	TH10500/D	Chrome frame	369

Harriet



Description	Code	Frame	Shell	Price £
Harriet visitor / meeting chair	TH10501/RD	Chrome frame	Red	216
Harriet visitor / meeting chair	TH10501/BL	Chrome frame	Blue	216
Harriet visitor / meeting chair	TH10501/GN	Chrome frame	Green	216
Harriet visitor / meeting chair	TH10501/GY	Chrome frame	Grey	216
Harriet visitor / meeting chair	TH10501/BK	Chrome frame	Black	216
Harriet visitor / meeting chair	TH10501/WH	Chrome frame	White	216

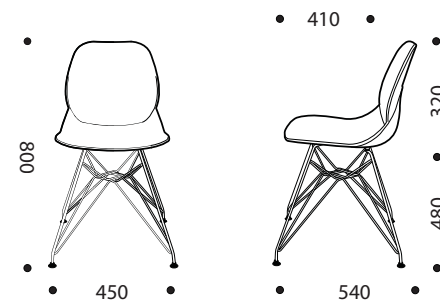

Grace



Description	Code	Mechanism	Arms	Price £
Upholstered in blazer fabric where applicable				
Grace lounge chair in white PU with white trumpet base	TG10707/WH	Swivel	Integrated	636
Grace lounge chair in white PU with chrome trumpet base	TG10707/CH	Swivel	Integrated	636
Grace lounge chair fully upholstered with white trumpet base	TG10700/WH	Swivel	Integrated	867
Grace lounge chair fully upholstered with chrome trumpet base	TG10700/CH	Swivel	Integrated	867

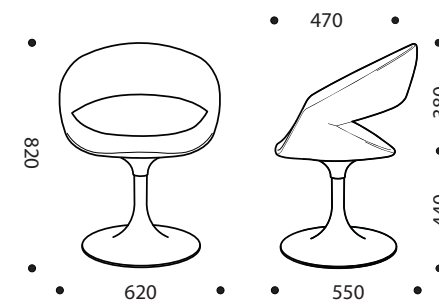

Elba

Aria

Description	Code	Price £
Elba sled base chair (no arms) / chrome frame / red shell	TB10001/RD	143
Elba sled base chair (no arms) / chrome frame / blue shell	TB10001/BL	143
Elba sled base chair (no arms) / chrome frame / green shell	TB10001/GN	143
Elba sled base chair (no arms) / chrome frame / grey shell	TB10001/GY	143
Elba sled base chair (no arms) / chrome frame / black shell	TB10001/BK	143
Elba sled base chair (no arms) / chrome frame / white shell	TB10001/WH	143
Elba sled base bar stool / chrome frame / red shell	TB50001/RD	205
Elba sled base bar stool / chrome frame / blue shell	TB50001/BL	205
Elba sled base bar stool / chrome frame / green shell	TB50001/GN	205
Elba sled base bar stool / chrome frame / grey shell	TB50001/GY	205
Elba sled base bar stool / chrome frame / black shell	TB50001/BK	205
Elba sled base bar stool / chrome frame / white shell	TB50001/WH	205
Linking clips with locking function Set of 2	TBLINK01	12
Eco linking clip (non locking) Set of 2	TBLINK02	8

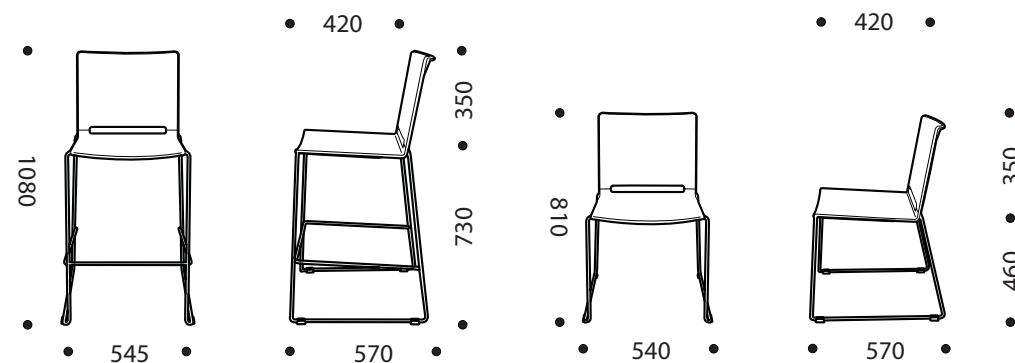

Description	Code	Frame	Price £
Shell Options Suffix Code: RD = Red, BL = Blue, GN = Green, GY = Grey, BK = Black, WH = White			
Upholstered in blazer fabric where applicable			
Aria sled base chair	TA10001	Sled	183
Aria sled base chair upholstered seat	TA10002	Sled	269
Aria sled base chair fully upholstered	TA10000	Sled	362
Aria 4 leg base chair	TA10501	4 Leg	183
Aria 4 leg base chair upholstered seat	TA10502	4 Leg	269
Aria 4 leg base chair fully upholstered	TA10500	4 Leg	362
Aria spider base chair	TA10901	Spider	268
Aria spider base chair upholstered seat	TA10902	Spider	334
Aria spider base chair fully upholstered	TA10900	Spider	432

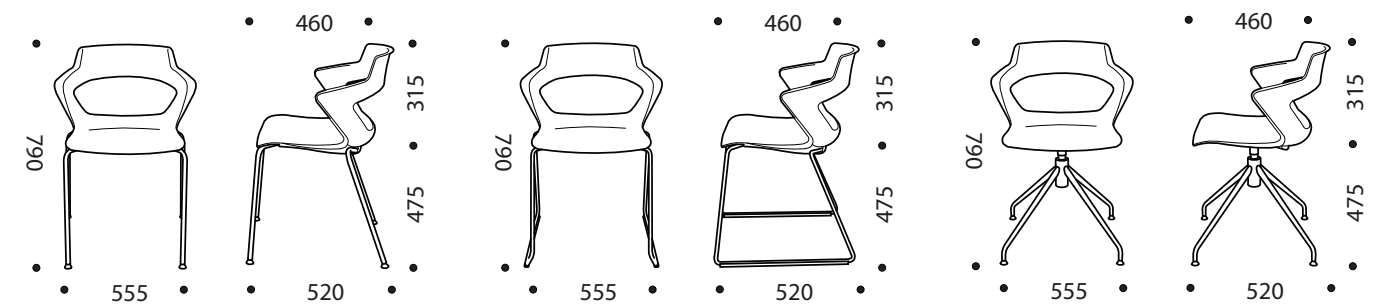

Norma



Description	Code	Base	Arms	Price £			
				A	B	C	D
Tub chair four leg spider base	MN10990	Chrome Swivel	Integrated	688	710	760	794
Tub chair 4 star base	MN10890	Chrome Swivel	Integrated	901	923	974	1007
Tub chair disc base	MN10790	Chrome Swivel	Integrated	923	945	996	1029

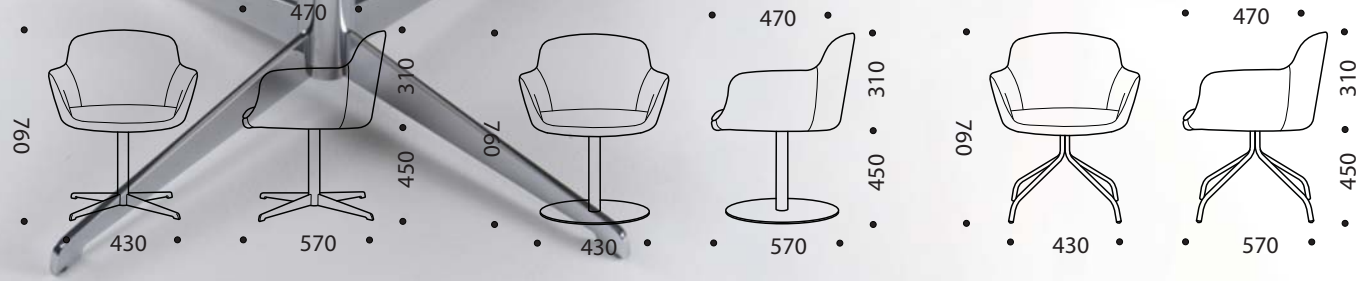

Emily



Description	Code	Frame	Arms	Price £	
				M	D
Emily chair sled base	TY20090	Sled	Integrated	453	740
Emily chair spider base	TY20990	Spider	Integrated	438	725
Emily chair 4 star base	TY20890	4 Star	Integrated	412	699

Specify required finish: M: Felt D: Blazer

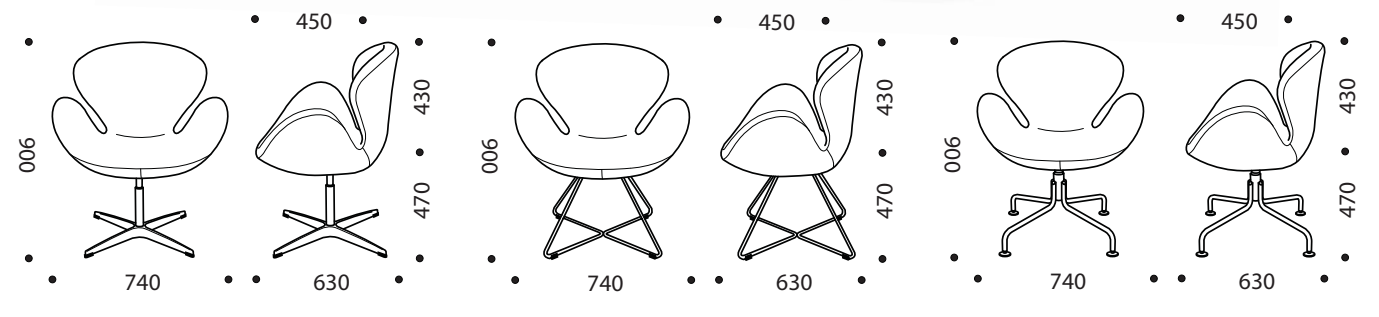

Papa

Description	Code	Price £	
		M	D
Specify required finish: M: Felt D: Blazer			
Papa 2 seater sofa ash legs	TP10060	1419	2033
Papa single armchair ash legs	TP10050	803	1317

Felt only available in light grey as shown

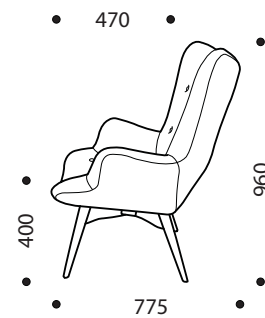
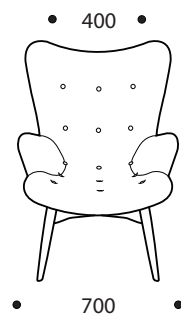
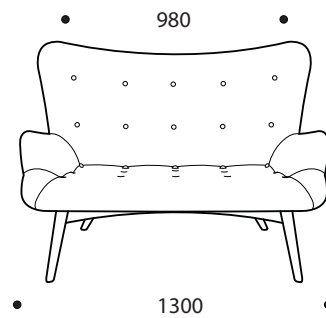

Auriga

Description	Code	Frame	Arms	Price £
One Seat Sofa	CC10050	Stainless Steel	Integrated	1101
Two Seat Sofa	CC10060	Stainless Steel	Integrated	1445
Three Seat Sofa	CC10070	Stainless Steel	Integrated	2003

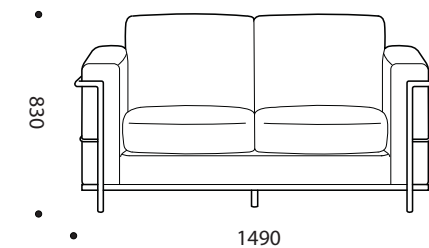
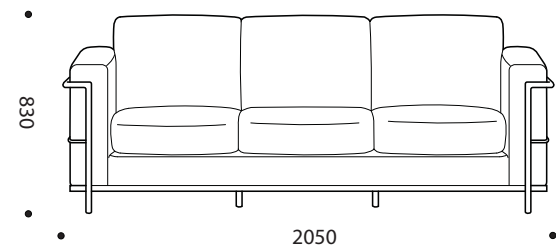
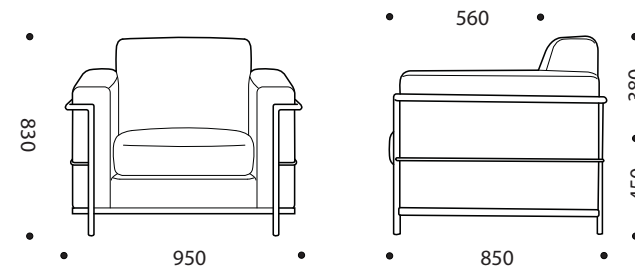

Avenue



Description	Code	Frame	Arms	Price £				
				A	B	C	D	F
One Seat Sofa	CD10050	Stainless Steel	Integrated	1142	1192	1310	1389	981
Two Seat Sofa	CD10060	Stainless Steel	Integrated	1736	1809	1978	2090	1555
Three Seat Sofa	CD10070	Stainless Steel	Integrated	2123	2218	2437	2583	1949

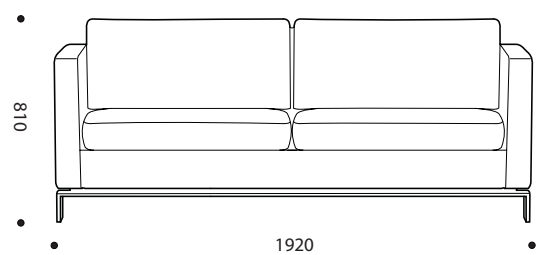
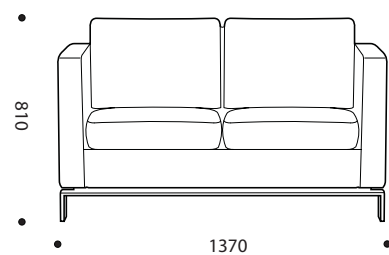
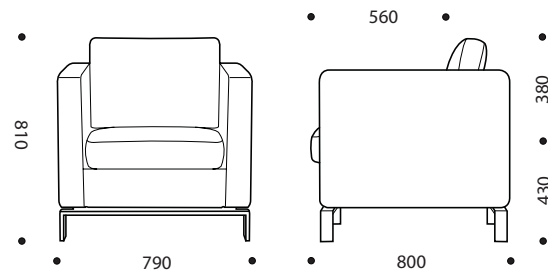

Ad-Hoc

Snug

Description	Code	Height	Width	Depth	Price £			
					A	B	C	D
Ad-Hoc single low back sofa	TD10050	845	850	720	1205	1277	1444	1556
Ad-Hoc single high back booth	TD30050	1350	850	720	1854	1979	2267	2459
Ad-Hoc 2 seat low back sofa	TD10060	845	1440	720	1676	1756	1942	2065
Ad-Hoc 2 seat high back booth	TD30060	1350	1440	720	2396	2529	2836	3041

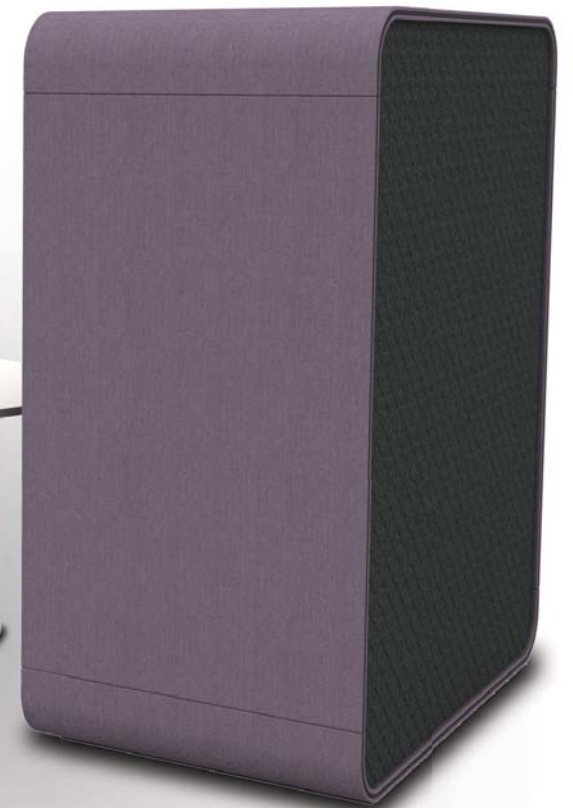

Description	Code	Height	Width	Depth	Price £	
					B	D
Specify required finish: B: Xtreme Plus D: Blazer with hourglass quilt back panel						
Snug seating booth	TC181485	1800	1400	850	4756	5625
Snug open seating booth	TC131485	1350	1400	850	3356	4037

Zone Meeting Pod

Zone Seating





Description	Code	Height	Width	Depth	Price £	
MFC Options: Beech, Cherry, Hacienda Black, Maple, Oak, Walnut, White, Zebrano					B	D
Only available with profiled ends.						
Specify required finish: B: Xtreme Plus D: Blazer						
Zone meeting pod	TXMPX-111427-P	1100	2700	1400	5633	6361
Zone meeting pod	TXMPX-131427-P	1350	2700	1400	5944	6727
Zone meeting pod with table	TXMPT-111427-P	1100	2700	1400	5789	6518
Zone meeting pod with table	TXMPT-131427-P	1350	2700	1400	6101	6884
Zone meeting pod with table and media panel	TXMPM-111427-P	1100	2700	1400	5991	6720
Zone meeting pod with table and media panel	TXMPM-131427-P	1350	2700	1400	6303	7086
Maximum screen width 750mm wide						



Description	Code	Height	Width	Depth	Price £	
MFC Options: Beech, Cherry, Hacienda Black, Maple, Oak, Walnut, White, Zebrano					B	D
S = Square ends, P = Profiled ends						
Specify required finish: B: Xtreme Plus D: Blazer						
Zone double seat module 1100mm high Shown with square ends	TXSSM-111410-S	1100	1400	1000	2804	3162
Zone double seat module 1350mm high Shown with square ends	TXSSM-131410-S	1350	1400	1000	2954	3338
Zone 2 double seat modules 1100mm high Shown with square ends	TX2SM-111410-S	1100	1400	1000	5341	6014
Zone 2 double seat modules 1350mm high Shown with square ends	TX2SM-131410-S	1350	1400	1000	5586	6302
Zone 3 double seat modules 1100mm high Shown with square ends	TX3SM-111410-S	1100	1400	1000	7023	7931
Zone 3 double seat modules 1350mm high Shown with square ends	TX3SM-131410-S	1350	1400	1000	7354	8320

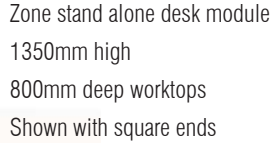

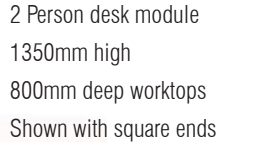

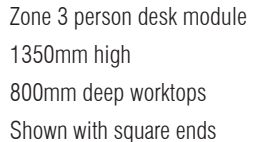

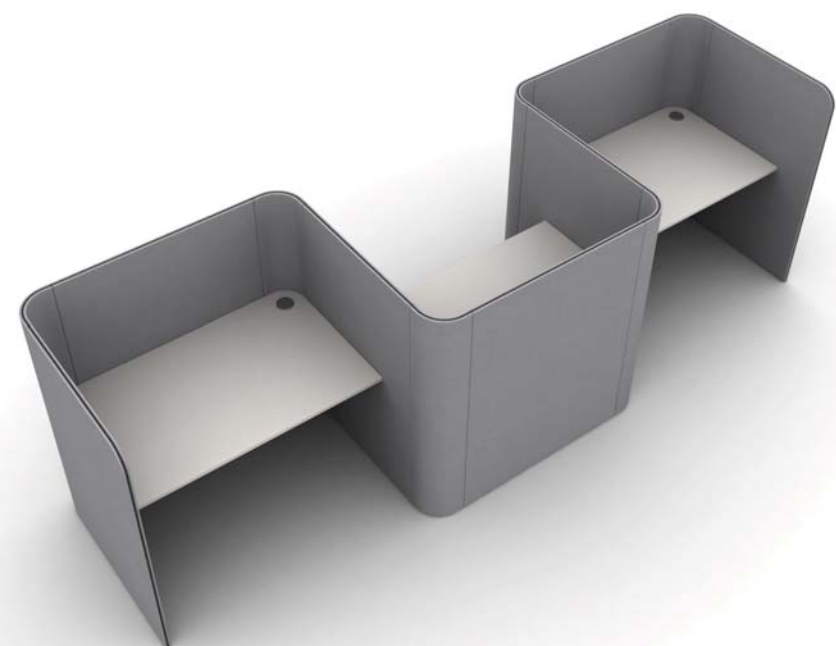
Shown with profiled ends

Description	Code	Height	Width	Depth	Price £		
					B	D	
MFC Options: Beech, Cherry, Hacienda Black, Maple, Oak, Walnut, White, Zebrano							
S = Square ends, P = Profiled ends							
Specify required finish: B: Xtreme Plus D: Blazer							
	Zone stand alone desk module	TXSDM-111010-S	1100	1000	1000	1602	1780
	1100mm high	TXSDM-111210-S	1100	1200	1000	1668	1855
	800mm deep worktops	TXSDM-111410-S	1100	1400	1000	1738	1933
	Shown with square ends	TXSDM-111610-S	1100	1600	1000	1807	2011
	Zone stand alone desk module	TXSDM-131010-S	1350	1000	1000	1730	1931
	1350mm high	TXSDM-131210-S	1350	1200	1000	1809	2021
	800mm deep worktops	TXSDM-131410-S	1350	1400	1000	1888	2110
	Shown with square ends	TXSDM-131610-S	1350	1600	1000	1967	2199
	2 Person desk module	TX2DM-111010-S	1100	1000	1000	2937	3252
	1100mm high	TX2DM-111210-S	1100	1200	1000	3027	3351
	800mm deep worktops	TX2DM-111410-S	1100	1400	1000	3120	3452
	Shown with square ends	TX2DM-111610-S	1100	1600	1000	3213	3554
	2 Person desk module	TX2DM-131010-S	1350	1000	1000	3138	3488
	1350mm high	TX2DM-131210-S	1350	1200	1000	3241	3601
	800mm deep worktops	TX2DM-131410-S	1350	1400	1000	3344	3714
	Shown with square ends	TX2DM-131610-S	1350	1600	1000	3446	3827
	Zone 3 person desk module	TX3DM-111010-S	1100	1000	1000	4271	4723
	1100mm high	TX3DM-111210-S	1100	1200	1000	4472	4949
	800mm deep worktops	TX3DM-111410-S	1100	1400	1000	4680	5182
	Shown with square ends	TX3DM-111610-S	1100	1600	1000	4888	5415
	Zone 3 person desk module	TX3DM-131010-S	1350	1000	1000	4546	5045
	1350mm high	TX3DM-131210-S	1350	1200	1000	4783	5313
	800mm deep worktops	TX3DM-131410-S	1350	1400	1000	5021	5582
	Shown with square ends	TX3DM-131610-S	1350	1600	1000	5255	5848

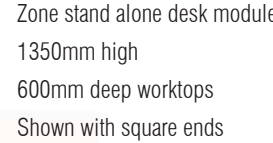

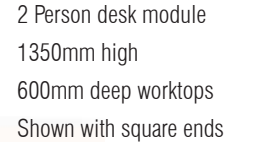
Shown with square ends

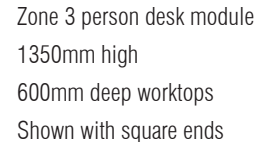
Description	Code	Height	Width	Depth	Price £		
					B	D	
MFC Options: Beech, Cherry, Hacienda Black, Maple, Oak, Walnut, White, Zebrano							
S = Square ends, P = Profiled ends							
Specify required finish: B: Xtreme Plus D: Blazer							
	Zone stand alone desk module	TXSDM-111080-S	1100	1000	800	1487	1649
	1100mm high	TXSDM-111280-S	1100	1200	800	1545	1715
	600mm deep worktops	TXSDM-111480-S	1100	1400	800	1605	1784
	Shown with square ends	TXSDM-111680-S	1100	1600	800	1665	1852
	Zone stand alone desk module	TXSDM-131080-S	1350	1000	800	1595	1775
	1350mm high	TXSDM-131280-S	1350	1200	800	1665	1855
	600mm deep worktops	TXSDM-131480-S	1350	1400	800	1735	1935
	Shown with square ends	TXSDM-131680-S	1350	1600	800	1804	2015
	2 Person desk module	TX2DM-111080-S	1100	1000	800	2841	3148
	1100mm high	TX2DM-111280-S	1100	1200	800	2956	3280
	600mm deep worktops	TX2DM-111480-S	1100	1400	800	3077	3417
	Shown with square ends	TX2DM-111680-S	1100	1600	800	3197	3554
	2 Person desk module	TX2DM-131080-S	1350	1000	800	2926	3245
	1350mm high	TX2DM-131280-S	1350	1200	800	3066	3406
	600mm deep worktops	TX2DM-131480-S	1350	1400	800	3206	3567
	Shown with square ends	TX2DM-131680-S	1350	1600	800	3344	3725
	Zone 3 person desk module	TX3DM-111080-S	1100	1000	800	4015	4433
	1100mm high	TX3DM-111280-S	1100	1200	800	4188	4631
	600mm deep worktops	TX3DM-111480-S	1100	1400	800	4369	4838
	Shown with square ends	TX3DM-111680-S	1100	1600	800	4549	5043
	Zone 3 person desk module	TX3DM-131080-S	1350	1000	800	4258	4716
	1350mm high	TX3DM-131280-S	1350	1200	800	4468	4957
	600mm deep worktops	TX3DM-131480-S	1350	1400	800	4678	5198
	Shown with square ends	TX3DM-131680-S	1350	1600	800	4885	5436

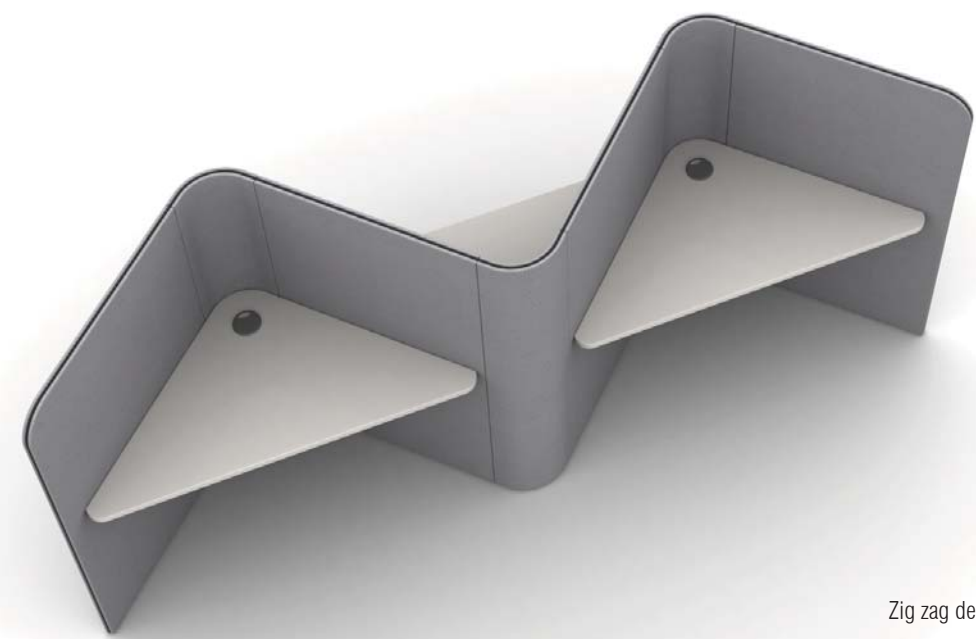

Zig zag desking specified on page 164

Zone Desking

Description	Code	Height	Width	Depth	Price £	
MFC Options: Beech, Cherry, Hacienda Black, Maple, Oak, Walnut, White, Zebrano					B	D
Only available with square ends.						
Specify required finish: B: Xtreme Plus D: Blazer						
Zone zig zag 2 person desk	TXZ2X-117422-S	1100	2246	742	1690	1868
	TXZ2X-137422-S	1350	2246	742	1819	2019
Zone zig zag 3 person desk	TXZ3X-117430-S	1100	3077	742	2401	2648
	TXZ3X-137430-S	1350	3077	742	2567	2842

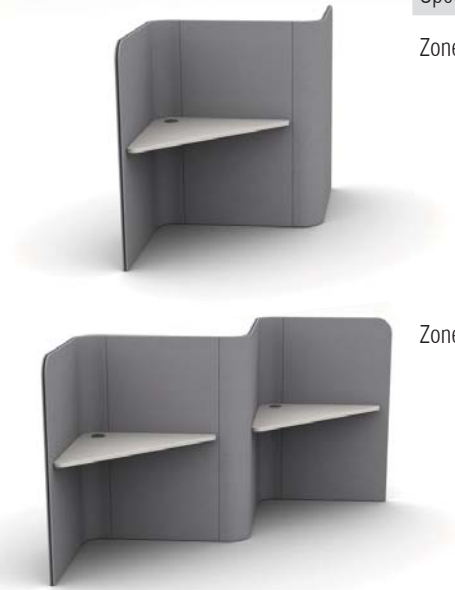

Zone Partitions

Description	Code	Height	Width	Depth	Price £	
Only available with square ends.					B	D
Specify required finish: B: Xtreme Plus D: Blazer						
Zone partition	TXPTX-118580-S	1100	850	800	1351	1504
	TXPTX-111080-S	1100	1050	800	1397	1559
	TXPTX-111680-S	1100	1650	800	1531	1718
	TXPTX-112080-S	1100	2050	800	1619	1823
Zone partition	TXPTX-138580-S	1350	850	800	1453	1623
	TXPTX-131080-S	1350	1050	800	1504	1684
	TXPTX-131680-S	1350	1650	800	1670	1881
	TXPTX-132080-S	1350	2050	800	1779	2011

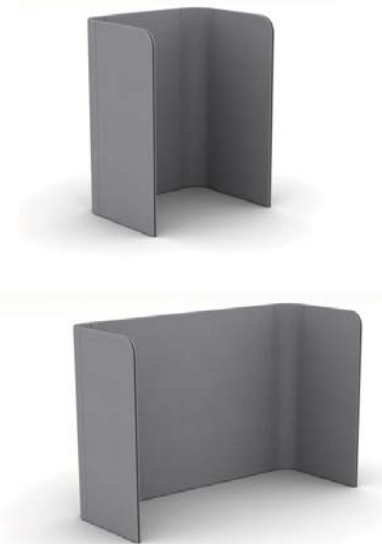

Zone Storage

Description	Code	Height	Width	Depth	Price £	
MFC Options: Beech, Cherry, Hacienda Black, Maple, Oak, Walnut, White, Zebrano					B	D
Only available with square ends.						
Specify required finish: B: Xtreme Plus D: Blazer						
Zone double door storage	TXQDX-118580-S	1100	850	800	1744	1897
	TXQDX-111080-S	1100	1050	800	1824	1986
	TXQDX-138580-S	1350	850	800	1846	2015
	TXQDX-131080-S	1350	1050	800	1932	2112
Zone twin double door storage	TXQDX-111680-S	1100	1650	800	2317	2504
	TXQDX-112080-S	1100	2050	800	2473	2677
	TXQDX-131680-S	1350	1650	800	2455	2666
	TXQDX-132080-S	1350	2050	800	2634	2866











Zone / Snug Accessories

Description	Code	Price £
Porthole power module 1 UK socket 1 x CAT 5e data Inc 3m leads	TXPH1P1D3M	99
Porthole power module 1 UK socket 2 x smart charge USB Inc 3m leads (As shown)	TXPH1P1D1USB3M	285
To be fitted to desk tops or seating module shelf		
Touch operated swan neck 2.75W 24V led flexible reading light inc driver and mains cable	TXLIGHT01	175
To be fitted to desk tops or seating module shelf		
Additional touch operated swan neck 2.75W 24V led flexible reading lights to add to existing driver Max 6 lights per driver	TXLIGHT02	91
LED up lighting strip for use on Snug or Zone seating modules To be fitted to seating modules Switch operated and including driver, mains cable and light housing	TXLIGHT03	389



Desking Finishes and Options

MFC Finishes

Option A	Finish	Code Suffix	Option B	Finish	Code Suffix
	White	WH		Romana Cherry	RC
	Maple	MA		Walnut	WA
	Beech	BE		Sand Zebrano	EZ
	Oak	MO		Hacienda Black	EH

Frame Finishes



Frame in Silver (S)



Frame in White (W)

Screen Finishes and Options







Fabric / Acrylic Price Bands

Screen Acrylics

(Available on S1, S3 and S4 screens)

Manufacturer	Fabric / Acrylic	Price Band
Camira	Cara	A
Camira	Advantage	B
Camira	Chateau	B
Camira	L2	B
Camira	Lucia	B
Camira	Manhattan	B
Camira	Phoenix	B
Camira	Racer	B
Camira	Sprint	B
Camira	Urban	B
Camira	Velocity	B
Camira	Vita	B
Camira	X2	B
Camira	Xtreme Plus	B
Bradbury	Galaxy	B
Bradbury	Pyra	B
Bradbury	Screen 66	B
Bradbury	Screen 72	B
Bradbury	Stirling	B
Perspex	Arctic Blue Frosted 7T77	C
Perspex	Black 9T30	C
Perspex	Green 6600	C
Perspex	Neutral Tint Smoke 9T20	C
Perspex	Opal Solid White 069	C
Perspex	Orange Amber 300	C
Perspex	Polar White Frosted 030	C
Perspex	Red 4401	C
Perspex	Sea Blue 7703	C
Perspex	Violet 886	C
Camira	Blazer Lite	D
Camira	Nexus	D
Camira	Aquarius	D
Camira	Blazer	D
Camira	Hemp	D
Camira	Hi-Tech	D
Camira	Oxygen	D
Camira	Marvel	D
Camira	Blazer Channel Quilt	E
Camira	Blazer Hourglass Quilt	E

Opaque Colours	Transparent Colours
	
Opal Solid White 069	Neutral Tint Smoke 9T20
	
Black 9T30	Sea Blue 7703
	
Violet 886	Red 4401
	
Polar White Frosted 030	Green 6600
	
Arctic Blue Frosted 7T77	Orange Amber 300

Door Options	Description	Lock Options	Type
	Silver Tambour Doors		Rim lock With master key system Standard on all lockable storage
	White Tambour Doors		Pull handle with integrated lock With master key system Available on lockers only
	Frosted Glass Doors		Combination lock With master key system Available on lockers only
			Electronic BeCode Air+ RFID lock With master key system Available on lockers only

Storage Carcass Options	Finish	Metal Storage Finish Options	Finish
	Silver Supplied as standard unless otherwise specified		Silver
	White Supplied as standard on white tambours, lockers and storagewall		White

Storage Details	Description
	Handle Options See page 103

Our range of modular reception counters can be assembled in a number of configurations, allowing the user to specify a counter that harmoniously fits within its environment, without incurring the cost associated with tailor made reception counters.

Each complete section can be used on its own or linked to another unit to create larger, bespoke configurations. A linking device facilitates simple re configuration of the units.

When specifying linked units, add the recessed leg pack to allow increased leg room (see page 121). When ordering, please suffix the code with the appropriate MFC colour option followed by the Acrylic colour (below) i.e.

MOREC08SLWAW - Walnut MFC/White Acrylic











AutoCAD blocks of each counter and space planning services are available, contact our design studio for further details.



Acrylic Colours

We use Parapan 4mm solid acrylic panels on all of our reception counters. Parapan is the finest quality high gloss solid acrylic on the market and the high gloss finish is on both sides of the material. Parapan acrylic is highly durable, moisture resistant and UV stable, so it will not fade. Available in the following colours as standard (other colours available upon request).

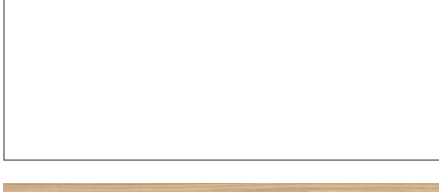

Finish Option Doors and Fascias	Finish	Code suffix	Storage Details
	Beech	BE	 <p>Handle 1185mm 844mm 544mm</p>
	Romana Cherry	RC	 <p>Post Slot Black Only</p>
	Hacienda Black	EH	
	Maple	MA	
	Oak	MO	<p>Specification Details</p> <p>The specification of all StorageWall and associated products is the direct responsibility of the customer. A site survey and completion of our survey questionnaire form (available upon request) is essential. We are able to provide a support service to customers planning StorageWall.</p> <p>It is the responsibility of the customer to provide comprehensive and accurate information. Please ensure that all dimensions are recorded. Dimensions supplied will be perceived as accurate. Please supply any necessary additional information taking into consideration skirting boards, light switches, fire alarms and any pipe work etc.</p> <p>The fitting of StorageWall units has been designed to be as straightforward as possible, however all installations are different and need to be treated as such.</p> <p>StorageWall units are provided unassembled and with separate components for assembly on site. StorageWall includes adjustable levelling feet, each capable of carrying 200kg max. These feet provide 45mm of adjustment to suit un-level floor surfaces. If more adjustment is required due to un-level floors, please contact us.</p> <p>All scribe panels are provided as finished MFC panels with ABS edging to all edges. These can be scribed and cut down to suit site conditions. The specification of the correct size panels and the cutting of these panels is the responsibility of the customer. It is advisable to specify oversized scribe panels wherever possible. This will allow as much tolerance on site as possible and will reduce the margin for error. All wall fixings are made at the fitter's discretion and require suitable fixings for the wall being affixed to.</p> <p>Push fit fixings have been provided wherever possible to provide a quick and effective installation solution. This system also allows panels to be added and removed easily without causing damage. This is particularly useful when scribing panels.</p>
	Walnut	WA	
	White	WH	
	Sand Zebrano	EZ	

Storage Carcass	Finish
	White

The StorageWall system has been designed with a number of integral features as standard to offer a complete storage solution. As well as double door storage units that can be specified with MFC shelves, lateral filing shelves, pull out filing cradles and slotted shelves, there are locker, recycling and file drawer units available as standard.

Each unit is available as starter, add on and end units allowing complete StorageWalls to be created made up of a range of storage solutions. The units have 25mm shared side panels and 25mm top panels, base panels and shelves.

All units are 2200 / 2500mm high and 1000mm or 500mm wide as standard providing ample storage. To create a bespoke, built in appearance the units can be specified with side panel extensions, infill panels and fascia panels. These are available in a range of sizes and can be scribed on site to suit and fixed using a push fit mechanism.

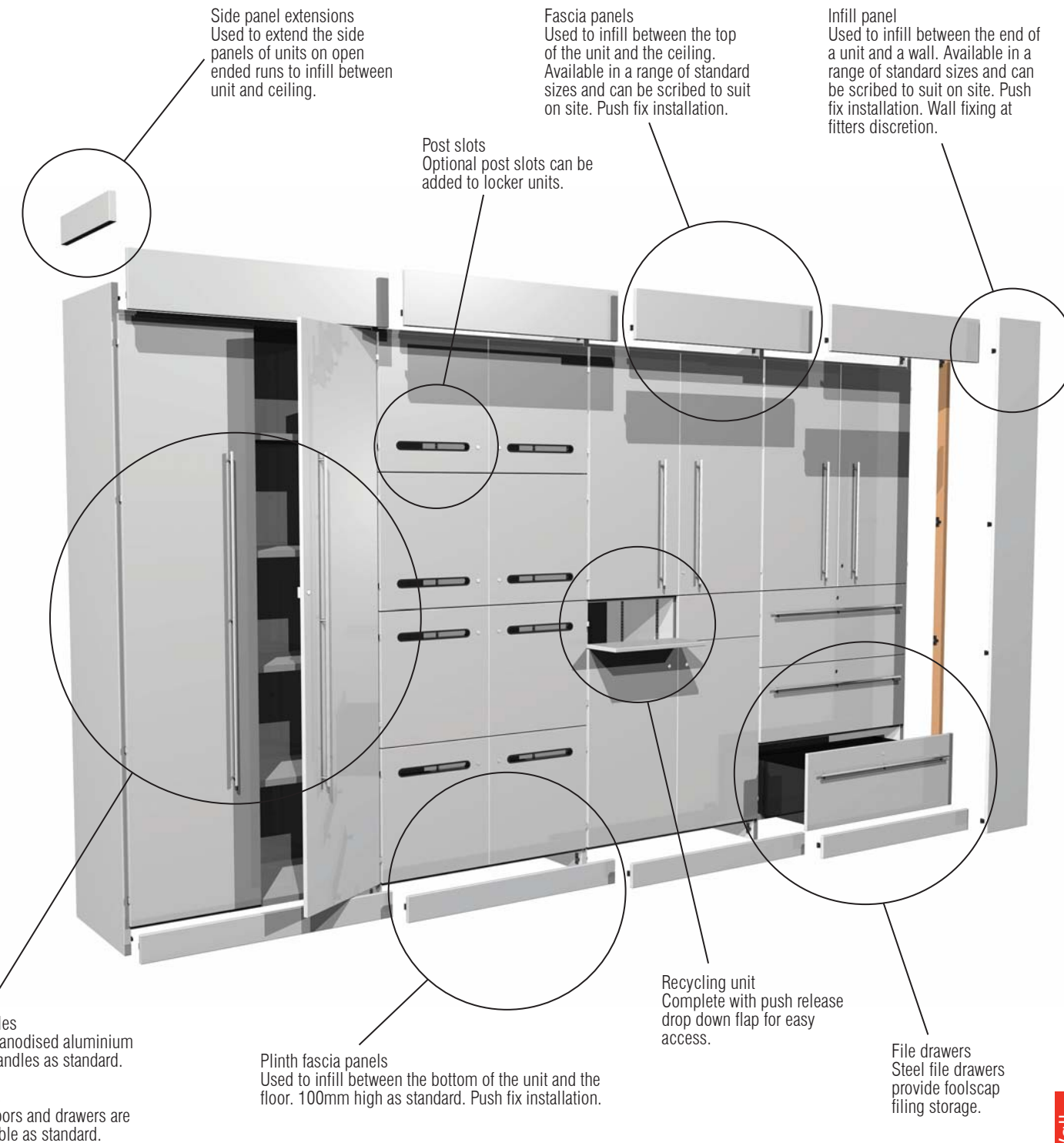

Seating Fabrics

Manufacturer	Fabric	Price Band
OEM	Felt	M
Camira	Advantage	A
Camira	Phoenix	A
Bradbury	Arizona	A
Bradbury	Fizz	A
Bradbury	Omega Plus	A
Bradbury	Pyra	A
Bradbury	Stirling	A
Camira	Chateau	B
Camira	Main Line	B
Camira	Manhattan	B
Camira	Sprint	B
Camira	Urban	B
Camira	Velocity	B
Camira	X2	B
Camira	Xtreme Plus	B
Bradbury	Figaro	B
Bradbury	Flamblend	B
Camira	Aspen	C
Camira	Blossom	C
Camira	Cedar	C
Camira	Hemp	C
Camira	Hi-Tech	C
Camira	Linden	C
Camira	Main Line Flax	C
Camira	Nexus	C
Camira	Poplar	C
Bradbury	Blenheim	C
Bradbury	Blenheim Check	C
Bradbury	Carnival	C
Camira	24 / 7+	D
Camira	Aquarius	D
Camira	Blazer	D
Camira	Hebden	D
Camira	Intervene Plain and Texture	D
Camira	Marvel	D
Camira	Oxygen	D
Camira	Silk	D
Camira	The Landscape Collection	D
OEM	Leather	F

All products are designed in accordance with the following standards:

BS EN 1335-3:2009	Office furniture. Office work chair. Safety test methods
BS EN 1335-2:2009	Office furniture. Office work chair. Safety requirements for users weighing up to 110Kg and used for up to 8 hours a day
BS EN 1335-1:2000	Office furniture. Office work chair. Dimensions. Determination of dimensions
BS EN ISO 9241-5:1999	Ergonomic requirements for office work with visual display terminals (VDT's). Workstation layout & postural requirements
BS EN 16139:2013	General contract use Meeting room and cafeteria chairs - structural testing
BS 5459-2:2000+A2:2008	Office furniture. Specification for performance requirements and tests. Office pedestal seating for users weighing up to 150 kg and used up to 24 hours a day.
BS 7176:2007+A1:2011	Specification for resistance to ignition of upholstered furniture for non-domestic seating by testing composites
BS EN 527-1:2011	Office furniture desk and table dimensions
BS EN 527-2:2002	Office furniture desk and table mechanical safety requirements
BS EN 527-3:2003	Office furniture desk and table methods to test for the determination of strength and stability
BS EN ISO 9241-5:1999	Ergonomic requirements for office work with VDT's, workstation layout and postural requirements
BS EN 14073-2:2004	Office storage furniture general safety requirements
BS EN 14073-3:2004	Office storage furniture methods for the determination of stability and strength of structure
BS EN 14074:2004	Office furniture desk and tables and storage, test methods for the determination of strength and durability of moving parts
BS 4875-7:2006	Test Level 4 – Domestic and contract storage furniture performance requirements – shelves.
BS 4875-7:1998	Strength and stability of furniture. Methods for determination of strength and durability of storage furniture
BS 4875-8:1998	Strength and stability of furniture. Methods for determination of stability of non-domestic storage furniture
BS EN 1023-1:1997	Office furniture, screens – dimensions
BS EN 1023-2:2000	Office furniture, screens - mechanical safety requirements
BS EN 1023-3:2000	Office furniture, screens – test methods



Prices	Are recommended retail (excluding VAT).
Dimensions	Are in millimetres and are nominal.
Wood Finishes	Beech, Cherry, Hacienda Black, Maple, Oak, Walnut, White, Zebrano. Pedestal and storage unit carcass are finished in Silver unless otherwise specified. White fronted tambour units, lockers and storagewall carcass are finished in white unless otherwise specified.
Frame Finishes	Aluminium Silver (RAL 9006) / White (RAL 9016)
Desking	All tops are 25mm thick MFC unless otherwise specified with impact resistant 2mm ABS profiled edges. All desking incorporates metal to metal fixings.
Pedestals	Tops are 25mm MFC thick on desk high pedestals, 18mm MFC on high mobile pedestals, with 2mm ABS profiled edges. Carcass and drawer fronts are 18mm thick. Flyover drawer fronts are fitted as standard. Handles are available as an optional extra. All pedestals are lockable. Master keys/replacement keys available - P.O.A. Full extension filing drawers with A4 or fooscap filing. Standard drawers are fitted with metal roller runners with a 25kg dynamic load capacity. Heavy duty pedestals are fitted with full extension ballbearing runners and an anti-tilt mechanism. 25kg load bearing capacity per drawer anti tilt mechanism is fitted as standard to heavy duty pedestals.
Storage	Tops are 25mm thick MFC with 2mm ABS profiled edges, carcass and fronts are 18mm thick. All units are lockable and fitted with levelling feet, adjustable from within the unit. Storage units are fitted with an internal adjustment system allowing full adjustability, supplied without shelves unless otherwise specified. Tambour fronts are supplied in Silver or White with matching carcass as standard.
Screens	move! screens are a full aluminium frame as standard including toolrail. S4 screens are a full aluminium frame as standard including toolrail. S3 multi functional aluminium toolrail, suitable for back to back configurations. S2 screens include linkable aluminium end uprights with aluminium toolrail. S1 screens are a solid core fabric wrapped screen with fabric edging. Desk mounted screens include mounting brackets as standard.
Guarantee	All products are guaranteed for a period of 5 years structural and 2 years moving parts & fabrics. This applies to seating used in a normal eight hour working day. For further information please contact customer services..
Manufacturing Procedures	All procedures are operated in line with ISO 9001 : 2000. All products are designed & manufactured in the UK. In the interests of design and development we reserve the right to alter specifications without prior notice.
Environmental Policy	All timber used is manufactured from managed and sustainable resources. Our manufacturing facilities are approved to the environmental standard 14001:1996 and FSC Chain of Custody accreditation.
Samples	All samples will be invoiced at the time of despatch. Provided the sample is returned within 30 days in good condition, a credit note will be issued. If however, a sample is not returned within the 30 day period it will be deemed sold and collection of the invoice amount will proceed. Any request for bespoke samples will be treated as an order and will therefore be chargeable.
Conditions of Business	This price list is subject to our standard terms and conditions of business, available on request.

This code applies to all of our operations and sets out the minimum standards expected from our staff in their internal and external dealings with colleagues, customers, and third parties.

1.1 Basic Standards of Conduct

- (a) We will conduct every aspect of our business with sincerity, integrity and honesty. We respect human rights and the interests of our employees, customers and third parties.
- (b) We will respect the legitimate interests of third parties with whom we have dealings in the course of our business.

1.2 Employees

- (a) We are committed to creating and maintaining a safe and healthy working environment for our employees.
- (b) We strive to create a workplace in which there is mutual trust and respect. An environment where every employee feels a responsibility for the performance and reputation of our company.
- (c) We respect the individual and each other's rights, customs and traditions including the right to freedom of association and the right to decide.
- (d) We will work towards achieving a diverse workforce, recruiting, employing and promoting employees only on the basis of objective criteria and the qualifications and abilities required for the job to be performed.
- (e) We will maintain good communications with employees through our information and consultation procedures.
- (f) We will assist employees in realising their potential.

1.3 Customers

- (a) We are committed to supplying quality products and excellent levels of service. We are flexible to and understand our customers' needs and demands.

1.4 Compliance with Law

- (a) We will comply with the laws and regulations applicable wherever we do business.

1.5 Business Integrity

- (a) We will not offer, give, seek or receive, either directly or indirectly, inducements or other improper advantages for business or financial gain and no employee may offer, give, seek or receive any gift or payment which is, or could be construed as such.

1.6 The Environment

- (a) We are committed to making continuous improvement in the management of our environmental impact.
- (b) We will work with our partners to promote environmental care, increase understanding of environmental issues and disseminate good practice.

1.7 Community Involvement

- (a) We endeavour to be a good corporate citizen and to fulfil our responsibilities to the societies and communities in which we operate.



Environmental Policy

We are committed to providing superior products whilst minimising any adverse impact to the environment. We recognise the importance of environmental protection and our duty to operate both responsibly and also in compliance with all legal requirements relating to the design, manufacture and distribution of office furniture. We aim to continually improve our environmental performance through the implementation of the three R's – Reduce, Reuse and Recycle. It is our priority to encourage our customers and suppliers to do the same, not only is this sound commercial sense, but we all have a duty of care towards future generations.

All MFC panels in standard products are procured only from suppliers which are certified as using timber from sustainable sources. In addition, as members of the Forest Stewardship Council (FSC®) we are committed to complying with the Policy for the Association of Organizations with FSC, FSC-POL-01-004 V2-0 EN, and FSC's mission to promote the environmentally appropriate, socially beneficial and economically viable management of the world's forests. Our 600kW Biomass boiler not only supplies our factory with heating but reduces our reliance on fossil fuels whilst at the same time improving our wood waste recycling rate.

Our commitment to the environment is reflected in our ISO 14001 Environmental Management System accreditation and also our ISO 9001 Quality Management System accreditation of which environmental concerns forms a substantive part. As a company we strive to always be environmentally aware and aim to continually improve our environmental performance through the implementation of the following:

- Assess and regularly re-assess the environmental effects of the Organisation's activities
- Training of employees in environmental issues
- Minimise material wastage
- Minimise energy wastage
- Promote the use of recyclable and renewable materials
- Reduce and/or limit the production of pollutants to water, land and air
- Control noise emissions from operations

We have a legal and ethical obligation to ensure our purchasing practices and standards place a priority on safety and are environmentally sound, efficient and well managed on behalf of our businesses, employees and customers. We work with our suppliers to ensure that they understand and adhere to our practices and business standards. There is no higher priority for us than the safety of our colleagues, customers, suppliers and local communities. We are committed to operating to the highest of legal standards, these standards are contained in our company policies including, Health & Safety, Environment, Quality, Equal Opportunity and Human Rights.

Credentials

Description	Accreditation	Certified
Quality Management System	ISO 9001	2008
Environmental Management System	ISO 14001	2004
Chain of Custody	FSC	2007



The mark of responsible forestry

Sustainability



Carbon Footprint

K2CW16LM

Category	CO2 (tonnes)
Timber / Board	12.722
Steel	18.050
Packaging	2.344
Others	1.037
Transport	2.550
Utilities	1.682
Total	38.384
Per Unit	0.038

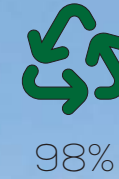
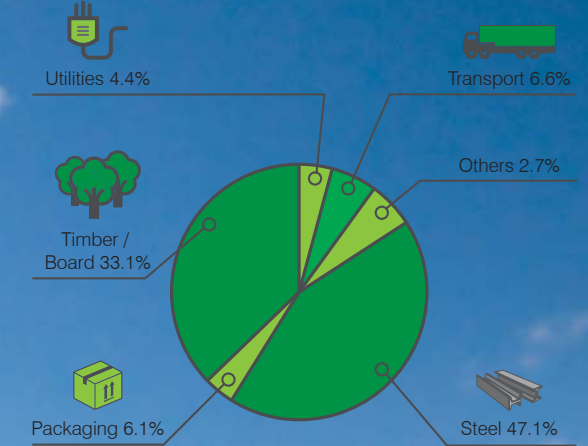

Recyclability K2CW16LM

Material	Percentage	Recyclable
Wood	61%	100%
Steel	34%	100%
ABS	3%	100%
Coatings and Adhesives	2%	0%
Total Recyclable Content		98%





Mobili
OFFICE

Innovation House
Snaygill Industrial
Estate
Keighley Road
Skipton BD23 2QR
T: 0870 050 1230
F: 0870 050 1233
E: sales@mobili.co.uk
W: www.mobili.co.uk