



1 lockers



2 shelving

All Probe products are available from a wide network of authorised Probe dealers



3 cupboards & work stations



4 kinetic mobile shelving



5 technic shelving



6 cloakroom



7 cabinets



8 ultrabox plastic lockers



MEETS
BS 4680:1996



PROBE

ULTRABOX[®]
PLASTIC LOCKERS



1

2

3

4

5

6

7

8

CHALLENGING ENVIRONMENTS

ULTRABOX[®]

STYLE, INDOORS OR OUTSIDE*

*If sheltered from direct rain



ULTRABOX INCLUDES LOCKS TYPE 1 OR 2

Request lock type at time of ordering.
See page 10 for the full range of locks.

ULTRABOX PLUS⁺

PERFORMS IN THE MOST CHALLENGING ENVIRONMENTS

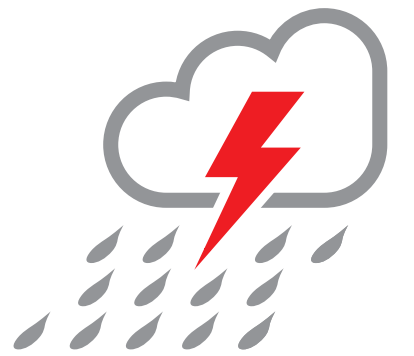

SEAL OUT THE WEATHER

WATERPROOF SEAL, PLUG AND LOCK GASKET
MAKES THE ULTRABOX PLUS FULLY WATERPROOF



WATERPROOF
DOOR SEAL

WATERPROOF
LOCK AND GASKET

WATERPROOF
DRAIN HOLE PLUG

ULTRABOX PLUS INCLUDES WATERPROOF LOCKS TYPE 2 OR 3

Request lock type at time of ordering.
See page 10 for the full range of locks.

SUITABLE FOR THE MOST CHALLENGING ENVIRONMENTS
AND ALL WEATHER CONDITIONS



PR[®]BE

www.probe-manufacture.co.uk

2



CHALLENGING ENVIRONMENTS



hygienic, hard wearing and anti-bacterial
99.9% REDUCTION OF BACTERIA INCLUDING MRSA & E-COLI for the life of the coating

3

- ▶ **CORROSION PROOF**
- ▶ **VANDAL RESISTANT**
- ▶ **HIGHLY WATER RESISTANT**
- ▶ **NO ON-SITE ASSEMBLY**
- ▶ **10 YEAR GUARANTEE^{††}**
- ▶ **GRAFFITI PROOF**

ULTRABOX[®] CHALLENGING ENVIRONMENTS
PLASTIC LOCKERS



www.probe-manufacture.co.uk

4

^{††}Terms and conditions apply, see www.probe-manufacture.co.uk for details.

NO ASSEMBLY REQUIRED



5



- ▶ NO ON-SITE ASSEMBLY
- ▶ VANDAL RESISTANT
- ▶ RUST PROOF
- ▶ 10 YEAR GUARANTEE^{††}
- ▶ WATERPROOF*
- ▶ ANTI-BACTERIAL
- ▶ ONE PIECE DESIGN FOR A NEATER FINISH AND SPEEDY INSTALLATION



AVAILABLE COLOURS FOR ULTRABOX LOCKERS

DOOR COLOUR



BODY COLOUR

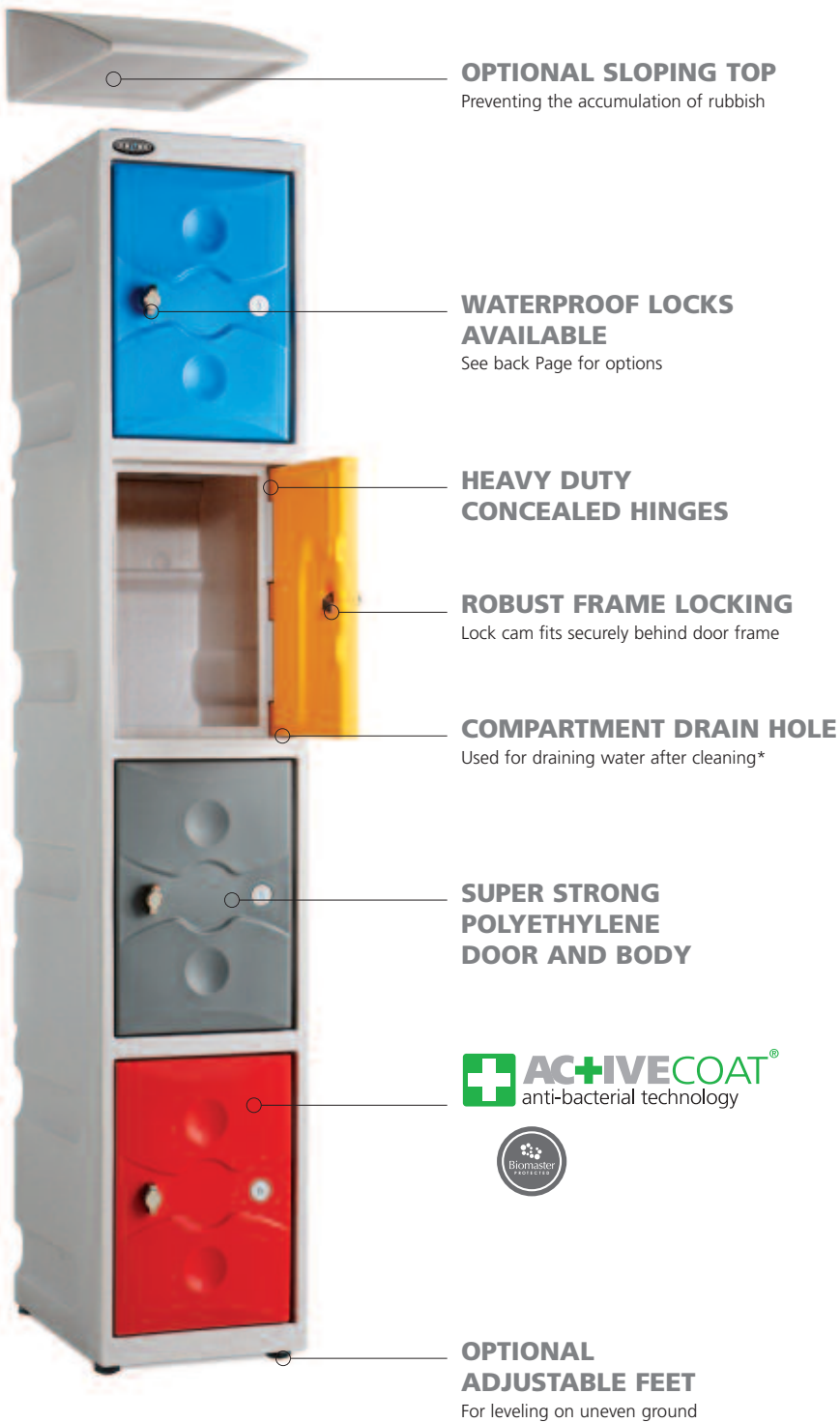

OPTIONAL WATERPROOF SEAL MAKES THE ULTRABOX PLUS FULLY WATERPROOF



HEAVY DUTY, VANDAL PROOF CONCEALED HINGES



COMPARTMENT DRAIN HOLE SITS NEATLY OUT OF SIGHT BEHIND THE DOOR*



AFTER WASHING THE LOCKER THE SLOPING SHELF DIRECTS WATER TO THE DRAIN HOLE
Drain hole is sealed on Ultrabox plus

*The drain hole is sealed on the Ultrabox Plus version



www.probe-manufacture.co.uk

CHALLENGING ENVIRONMENTS



hygienic, hard wearing and anti-bacterial
99.9% REDUCTION OF BACTERIA INCLUDING MRSA & E-COLI for the life of the coating

^{††}Terms and conditions apply, see www.probe-manufacture.co.uk for details.



OUR PREFERRED CANOPY SUPPLIER

t: 01538 380 080 www.falco.co.uk



www.probe-manufacture.co.uk

††Terms and conditions apply, see www.probe-manufacture.co.uk for details.

NO ASSEMBLY REQUIRED



ULTRABOX[®]

STYLE, INDOORS OR OUT*

*If sheltered from direct rain



A RANGE OF LOCKS SHOWN HERE
FOR ILLUSTRATION PURPOSES
SEE BACK PAGE FOR FULL RANGE



PRBE

www.probe-manufacture.co.uk

10

††Terms and conditions apply, see www.probe-manufacture.co.uk for details.

ULTRABOX PLUS⁺

PERFORMS IN THE MOST
CHALLENGING ENVIRONMENTS

**SUITABLE FOR EXTREME ENVIRONMENTS
AND ALL WEATHER CONDITIONS**

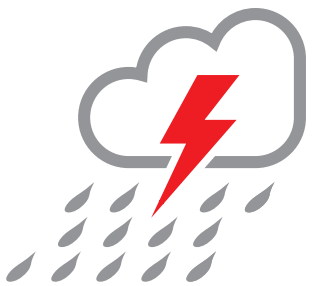

CHALLENGING ENVIRONMENTS



ACTIVECOAT[®]
anti-bacterial technology

hygienic, hard wearing and anti-bacterial
99.9% REDUCTION OF BACTERIA INCLUDING MRSA & E-COLI for the life of the coating

11



www.probe-manufacture.co.uk

12

^{††}Terms and conditions apply, see www.probe-manufacture.co.uk for details.

NO ASSEMBLY REQUIRED



13

ULTRABOX[®] NESTING

All Ultrabox lockers can be securely nested with basic tools. The preformed guide indentation in each corner of the locker is simply drilled out with an 8mm drill bit, then a nut and bolt with a waterproof gasket is inserted in each hole creating a secure, waterproof connection between the lockers.

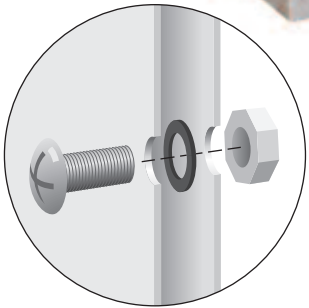

Pre formed indentations allow for easy drilling and bolting when nesting is required. Rubber gasket ensures a secure and water proof connection between lockers.

ULTRABOX[®] SEATS & STANDS

A range of seats and stands are available for Ultrabox lockers keeping them off the ground for situations where there may often be standing water. Stands are available to accommodate 1, 2, 3 or 4 lockers and can be combined to hold as many lockers as you require.

SIZES AVAILABLE TO ACCOMMODATE BANKS OF 1, 2, 3 OR 4 LOCKERS WIDE

Stands can be combined to accommodate any number of lockers.

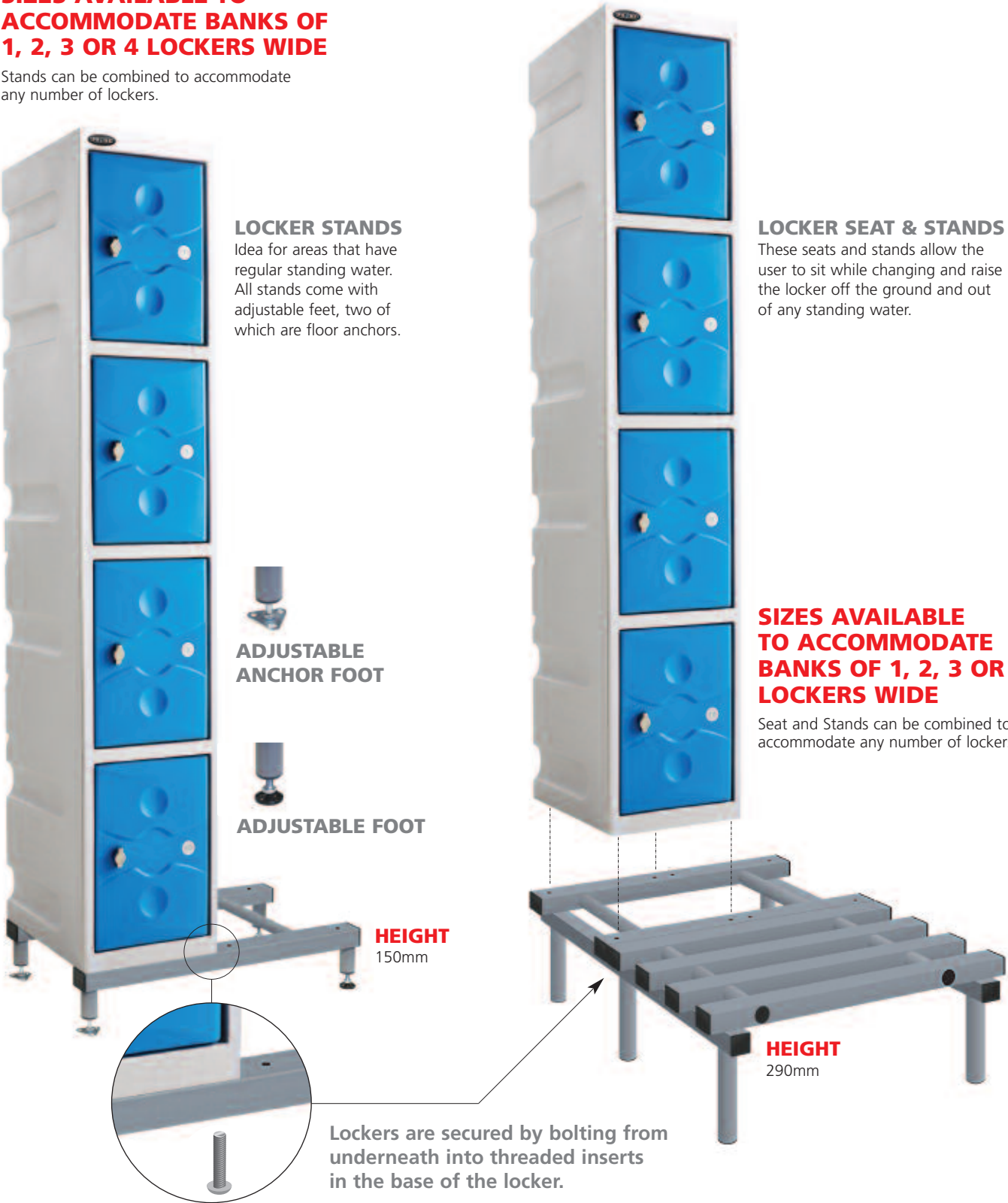

LOCKER STANDS
Idea for areas that have regular standing water. All stands come with adjustable feet, two of which are floor anchors.

LOCKER SEAT & STANDS
These seats and stands allow the user to sit while changing and raise the locker off the ground and out of any standing water.

SIZES AVAILABLE TO ACCOMMODATE BANKS OF 1, 2, 3 OR 4 LOCKERS WIDE

Seat and Stands can be combined to accommodate any number of lockers.

CHALLENGING ENVIRONMENTS



^{††}Terms and conditions apply, see www.probe-manufacture.co.uk for details.

MATERIAL SPECIFICATION



Product made from MDPE (Medium High Density Polyethylene)
Carcass, Doors and Shelves.
The Material can work in severe climatic conditions from -29°C to 40°C

ULTRA VIOLET PROTECTION (UV)



By adding a UV stabilizer HALS (hindered amine light stabilizer UV15) PE material can last up to 15 years in Northern Europe, but this can be time may be less in very harsh environment ie. (Deserts, or the ocean Pacific). This means that after 12 years in the Northern regions, 50% of the original mechanical properties are left.
If no UV stabilizers are present then the product will become brittle over time and colours will fade.

PRODUCT GUARANTEE



Probe warrants to commercial and institutional purchasers only each new UltraBox locker unit purchased from us to be free from defects in materials and workmanship under normal use and service for a period of one year and be free from rust, delamination or breakage of any plastic components for a period of 10 years under normal use. This warranty is measured from the date of our invoices, upon the following terms and conditions:
This warranty is limited to replacing or repairing, at our option, transportation charges prepaid by the purchaser, any UltraBox locker unit or part therefore which our inspection shall show to have been defective within the limitations of this warranty.
This warranty does not cover installation labour charges and does not apply to any units that have been damaged by accident, abuse, improper installation, improper maintenance, or altered in any way.

ANTI-MICROBIAL RESISTANCE



Revolve N-272 protects your lockers from bacteria and the problems associated with bacteria. The antibacterial additive used is inorganic, and is able to inhibit the growth of bacteria, mold and yeast. The functional additive works from the inside out and prevents microbial growth in micro-cracks, dead spots and rough surfaces. Revolve N-272 protection gives better performance than the organic version since it is effective also against MRSA.

RECYCLING



The Material used in the production of the UltraBox Locker is able to be fully recycled The plastic recyclables are then shredded. These shredded fragments then undergo processes to eliminate impurities like paper labels. This material is melted and often extruded into the form of pellets, which are then used to manufacture other products.

FOOD GRADE



The material in this product is safe for food contact. The food safe symbol generally assures that the container surface is free of any toxic contaminants which could be contacted from the manufacturing process and that the material the container is made of shall not potentially become a source of toxic contamination through usage.

AVAILABLE COLOURS FOR ULTRABOX LOCKERS

DOOR COLOUR

RED
RAL 3020

BLUE
RAL 5015

YELLOW
RAL 1028

GREY
RAL 7031

BODY COLOUR

SPECKLED GREY
RAL 7047

CARE OF PRODUCT

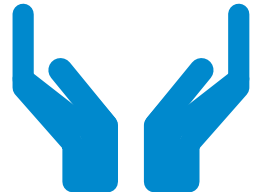

To provide plastic lockers with the proper care and maintenance, the following instructions must be followed:
All surfaces should be cleaned with a mild liquid soap only. The finish should then be wiped and dried. In areas containing showers, either self-contained or tiled-in units, the lockers in these rooms must receive ventilation from the outside so that humidity can escape.

UNDER NO CIRCUMSTANCE SHOULD THE FOLLOWING AGENTS BE USED:

- Abrasive powder or scouring pads
- Ceramic tile cleaners
- Solutions containing more than 1% by volume of ammonia
- Solutions containing acids or lye
- Solutions containing enzymes

If the above instructions are adhered to our products provide years of dependable service. Probe Storage shall not accept responsibility for product failure if the above instructions are not followed.

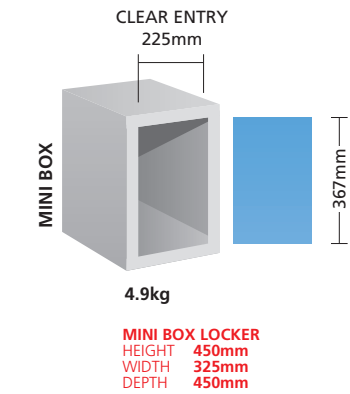
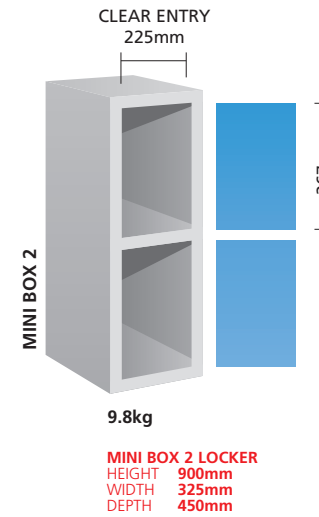
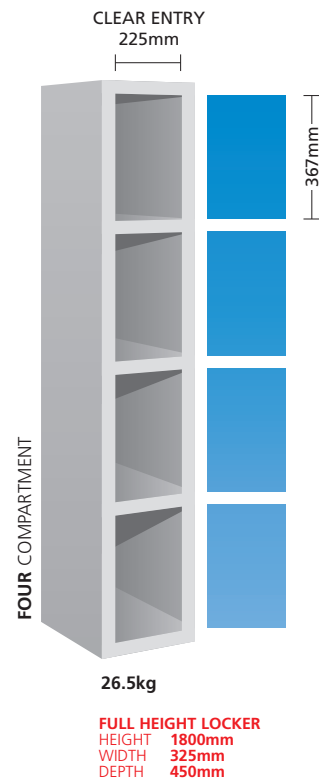
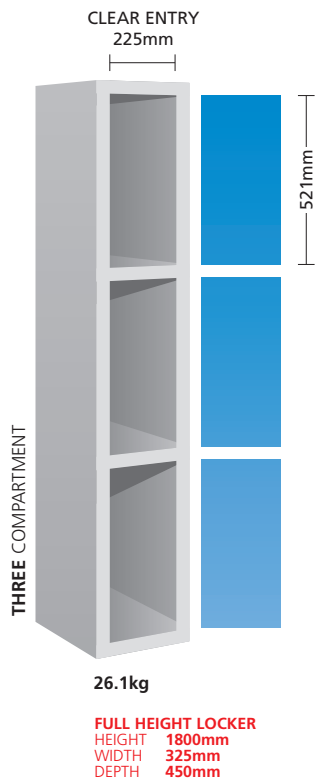
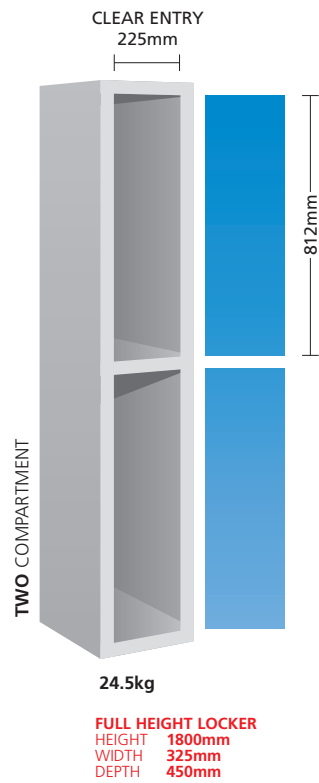

FULLY WATERPROOF



WATERPROOF HASP & STAPLE
This design allows easy padlock fitting. Shank diameter min 5mm - max 7mm. Padlock sold separately.

- **WATERPROOF**



WATERPROOF CAM LOCK
This is a Waterproof Chlorine resistant high quality 7 pin tumbler system with a nickel silver key. Its all brass construction lends itself for use in harsh environments such as swimming pools.

Two keys are included with each standard lock.

- **WATERPROOF**
- **CHLORINE RESISTANT**



DIGITAL COMBINATION LOCK 40,000 COMBINATIONS

- **WATERPROOF**
- **CHLORINE RESISTANT**
- Simple to program
- Batteries last up to 50,000 operations
- Single user supplied as standard
- Multi user option available (specify when ordering)



WATERPROOF COIN/TOKEN - RETURN/RETAIN
These Waterproof and Chlorine resistant locks are available with coin denominations £/€ or tokens, for either return or retain.

- **WATERPROOF**
- **CHLORINE RESISTANT**

BUDGET 'DRY VERSION' AVAILABLE



WEATHER RESISTANT



WATER RESISTANT CAM LOCK
Micro sprung 10 disc lock incorporating spring loaded weather shield. This lock features a massive 3000 serial combinations all exclusive to Probe.

Two keys are included with each standard lock.

- **WEATHER RESISTANT**



RE-ENGINEERED RE-PROGRAMMABLE COMBINATION LOCK
Reprogrammable Combination Lock, tough Zinc Alloy housing and dials with 10,000 possible combinations. Lost codes reset with key, sold separately. Suitable for multi user applications.

- **WEATHER RESISTANT**

WATER PROOF

Suitable for the most challenging environments and all weather conditions

WEATHER RESISTANT

Suitable for indoors or out if sheltered from direct rain

NO WEATHER PROTECTION

For internal use where not exposed to water or chlorine

NO WEATHER PROTECTION



RE-PROGRAMMABLE COMBINATION LOCK
Re-programming using service key
Easy to use front facing dial with 10,000 combinations. One Service Key required per installation, Service Key sold separately. Not recommended for multi user applications.



DIGITAL COMBINATION LOCK 40,000 COMBINATIONS

- Simple to program
- Batteries last up to 50,000 operations
- Single user supplied as standard
- Multi user option available (specify when ordering)
- Emergency access using service key

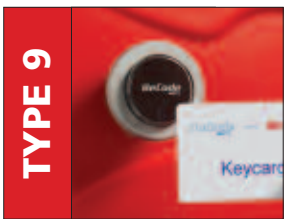

BeCode Air+ RFID Technology
The BeCode Air+ only has to be 'shown the card' (or matching transponder) to operate. No external programming devices needed. 10,000 closings with one battery. It doesn't get any simpler.

ULTRABOX PLUS



WATERPROOF DOOR SEAL

WATERPROOF LOCK GASKET

WATERPROOF DRAIN HOLE PLUG

SEAL OUT THE WEATHER
WATERPROOF SEAL, PLUG AND LOCK GASKET MAKES THE ULTRABOX PLUS FULLY WATERPROOF†

†We recommend the use of weather resistant or waterproof locks

OPTIONAL ADJUSTABLE FEET FOR UNEVEN FLOORS



OPTIONAL SLOPING TOP PREVENTING THE ACCUMULATION OF RUBBISH

Sloping top increases the locker height by 150mm



OPTIONAL WATERPROOF SEAL MAKES THE ULTRABOX PLUS LOCKER FULLY WATERPROOF



DRAIN HOLE SITS NEATLY OUT OF SIGHT BEHIND THE DOOR ALLOWING THE INSIDE TO BE JET WASHED AND THE WATER TO DRAIN

Drain hole is sealed on Ultrabox plus



SLOPING SHELF ALLOWS JET WASH WATER TO DRAIN TOWARDS THE DRAIN HOLE

Drain hole is sealed on Ultrabox plus



DOUBLE COAT HOOK FITTED IN ALL TWO DOOR LOCKERS



OPTIONAL NUMBER PLATE



Included in 'Ultrabox' locker price. Request lock type at time of ordering.

†Terms and conditions apply, see www.probe-manufacture.co.uk for details.